

# Development of Distributed LFC Controllers Using Adaptive Wiegthed PSO Algorithm

*Rania Helmy Mansour Hennas*

Graduate Master Student, Cairo University,  
Faculty of Engineering, Electric Power and  
Machines Dept., Giza, Egypt.  
rony\_rany@yahoo.com

*Magdy A.S. Aboelela*

Cairo University, Faculty of  
Engineering, Electric Power and  
Machines Dept., Giza, Egypt.  
aboelamagdy@yahoo.com

*Hassen T. Dorrah*

Cairo University, Faculty of  
Engineering, Electric Power and  
Machines Dept., Giza, Egypt.  
dorrahht@aol.com

**Abstract-** This paper focuses on the application of PI/PID controller tuned with Adaptive Weighted Particle Swarm Optimization (AWPSO) algorithm on the load frequency control of power systems. This effect will be studied for two areas power systems with multiple thermal energy resources and a stand alone gas turbine system. A load deviation of different values is assumed in both areas. The retain of the working frequency within a reasonable short time is the main function of the well tuned PI/PID controller. A Matlab/Simulink model with practical system parameters has been designed in order to show the outcomes of this research work. The results show the ability of the proposed technique to keep the frequency in its permissible range even with the presence of load changes in both areas.

**Keywords-** AWPSO, Load Frequency Control, Thermal power station, Gas power station, PID controllers, and Matlab/Simulink.

## I. INTRODUCTION

Frequency is an explanation of stability criterion in power systems [1]. To provide the stability, active power balance and steady frequency are required. Frequency depends on active power balance. If any change occurs in active power demand/generation in power systems, frequency cannot be hold in its rated value. So oscillations increase in both power and frequency. Thus, system subjects to a serious instability problem. In electric power generation, system disturbances caused by load fluctuations result in changes to the desired frequency value. Load Frequency Control (LFC) is a very important issue in power system operation and control for supplying sufficient and both good quality and reliable power [3]. Power networks consist of a number of utilities interconnected together and power is exchanged between the utilities over the tie-lines by which they are connected. The net power flow on tie-lines is scheduled on a priori contract basis. It is therefore important to have some degree of control over the net power flow on the tie-lines. Load Frequency Control (LFC) allows individual utilities to interchange power to aid in overall security while allowing the power to be generated most economically. The variation in Load frequency is an index for ordinary operation of the power systems. When the load perturbation takes place, it will affect the frequency of other areas also. To improve the stability of the power networks, it is necessary to design Load Frequency Control (LFC) systems that control the power generation and active power. Because of the relationship between active power and frequency, three level automatic generation controls have been proposed by

power system researchers [4]. Generally, ordinary LFC systems are designed with Proportional-Integral (PI) controllers [5]. However, since the "I" control parameters are usually tuned; it is incapable of obtaining good dynamic performance for various load and system changes. Many studies have been carried out in the past on this important issue in power systems, which is the load frequency control. In literature, many control strategies have been suggested based on the conventional linear control theory [6-10]. These controllers may be improper in some operating conditions. This could be due to the complexity of the power systems such as nonlinear load characteristics and variable operating points. In a new study, different intelligent techniques such that Fuzzy Logic, *Genetic Algorithm* (GA) and *Particle Swarm Optimization* (PSO) algorithms has been used to determine the parameters of a PID controller according to the system dynamics [11]. In the integral controller, if the integral gain is very high, undesirable and unacceptable large overshoots will be occurred. However, by adjusting the maximum and minimum values of proportional ( $k_p$ ), integral ( $k_i$ ) and derivative ( $k_d$ ) gains respectively, the outputs of the system (voltage, frequency) could be improved. The overshoots and settling times with the proposed AWPSO based PID controller are better than those of the conventional PSO based PID controllers.

## II. PROBLEM FORMULATION

In order to keep the power system in normal operating state, a number of controllers are used in practice. As the demand deviates from its normal operating value the system state changes. Different types of controllers based on classical linear control theory have been developed in the past [12-16]. Because of the inherent nonlinearities in system components and synchronous machines, most load frequency controllers are primarily composed of an integral controller [12-19]. The integrator gain is set to a level that compromise between fast transient recovery and low overshoot in the dynamic response of the overall system. This type of controller is slow and does not allow the controller designer to take into account possible non-linearity in the generator unit so the PID controller will be used for the stabilization of the frequency in the load frequency control problems. The main objectives of LFC In order to regulate the power output of the electric generator within a prescribed area in response to changes in system frequency, tie

line loading so as to maintain the scheduled system frequency and interchange with the other areas within the prescribed limits.

Family of the computational intelligence techniques ranges from Evolutionary Computation (EC) which models natural evolution including genetic and behavioral evolution Fuzzy Systems (FS) which originated from how organisms interact with their environment, Artificial Neural Network (ANN) which models biological neural (Human brain) systems, Swarm Intelligence (SI) which models social behavior of organisms living in swarms which is known as Particle Swarm Optimization (PSO) and the other algorithm is Ant Colony (ACO) and Artificial Immune System (AIS) which models the human immune system. Also genetic Algorithms (GA) and Bacteria foraging techniques have been applied to many case study where LFC is one of them [16-17].

Particle Swarm Optimization (PSO) algorithm is further improved to Adaptive Weighted PSO (AWPSO) for enhancing the performance of PSO [24].

#### A. PID Controller

PID controller is considered to be a key component of industrial control system because of its capability of improving the dynamic response of the system and reducing the steady state error. PID controller involves three parameters P, I and D where P depends on the present error, I depends on accumulation of past errors and D is a prediction of future errors based on current rate of change. The transfer function for the PID controller is

$$C(s) = k_p + \frac{k_i}{s} + k_d s \quad (1)$$

#### B. Adaptive Weighted Particle Swarm Optimization (AWPSO)

Particle swarm optimization is one of the swarm intelligence forms in which the behavior of biological social system like a flock of bird [19] is simulated. This algorithm is introduced by Eberhart and Kennedy in 1995 [20, 23]. When a swarm looks for food, its particles will spread in the environment and move around independently. Each particle in the swarm flies in the search space with a degree of freedom or randomness in its movements with dynamically adjusted velocity according to its own flying experience and its neighbors flying experience. Each particle is treated as a volume less particle in G dimensional search space [24].

Each particle keeps track of its coordinates in the problem space, which is associated with the best position (solution) it has achieved. This position is called  $P_{best}$ . Another best value that is tracked by the global version of the particle swarm optimizer is the overall best value and its location is called  $g_{best}$  obtained by any particle in the swarm. The performance of each particle is evaluated using fitness (cost) function [25]. The PSO is represented mathematically in a form of Particle Velocity  $V_{ij}(t)$  and Particle position  $X_{ij}(t)$  as follows:

$$V_{ij}(t) = W \cdot V_{ij}(t-1) + C_1 \cdot \text{rand}(0,1) \cdot (P_{best} - X_{ij}(t-1))$$

$$+ C_2 \cdot \text{rand}(0,1) \cdot (g_{best} - X_{ij}(t-1)) \quad (2)$$

$$X_{ij}(t) = X_{ij}(t-1) + V_{ij}(t) \quad (3)$$

$$i = 1, 2, 3 \dots, N \quad (4)$$

$$j = 1, 2, 3 \dots, d \quad (5)$$

Where

$V_{ij}(t)$	Velocity of the particle $i$ at iteration $t$ ;
$X_{ij}(t)$	Current position of particle $i$ at iteration $t$ ;
$W$	Inertia weight;
$C_1, C_2$	Cognitive and social acceleration coefficient;
$\text{rand}(0, 1)$	random number between 0 and 1;
$P_{best}$	Particle $i$ best position;
$g_{best}$	Global best position;
$N$	Number of particles;
$d$	Dimension;
$t$	time;

Adaptive Weighted PSO (AWPSO) algorithm is developed later by Mahfouf [26] for improving the performance of the PSO algorithm. The adaptive weighted PSO is achieved by two terms: Inertia weight ( $W$ ) and Acceleration factor ( $A$ ). The inertia weight function is to balance global exploration and local exploration [27]. It controls previous velocities effect on the new velocity. Larger the inertia weight, larger exploration of the search space while smaller the inertia weights, the search will be limited and focused on a small region in the search space. The inertia weight formula is as follows which makes  $W$  value changes randomly from  $W_o$  to 1:

$$W = W_o + \text{rand}(0,1) (1 - W_o) \quad (6)$$

Where  $W_o$  is an initial positive constant in the interval  $[0, 1]$

The Acceleration factor formula is

$$A = A_o + \frac{i}{n} \quad (7)$$

where  $i$  is current generation,  $n$  denotes the number of generations and  $A_o$  is an initial positive constant in the interval  $[0.5, 1]$ .

The particle Velocity  $V_{ij}(t)$  is rewritten incorporating Acceleration factor as follows:

$$V_{ij}(t) = W \cdot V_{ij}(t-1) + A \cdot C_1 \cdot \text{rand}(0,1) \cdot (P_{best} - X_{ij}(t-1)) + A \cdot C_2 \cdot \text{rand}(0,1) \cdot (g_{best} - X_{ij}(t-1)) \quad (8)$$

#### C. PI/PID controller Tuning procedure using AWPSO

The search procedures of the AWPSO for finding the optimal values of the PID controller are as follows:

**Step 1:** Specify upper and lower bound of the PID controller parameter. The upper and lower bound values depend on the controlled system characteristics.

**Step 2:** Initialize randomly the particles position and velocity.

**Step 3:** Calculate the values of the cost function in the time domain.

**Step 4:** Compare each particle evaluation values with its best position  $P_{best}$ . The best evaluation value among the  $P_{best}$  value is denoted as  $g_{best}$ .

**Step 5:** Update the velocity of each particle in the swarm according to the following formula

$$V_{ij}(t) = W \cdot V_{ij}(t-1) + A \cdot C_1 \cdot \text{rand}(0,1) \cdot (P_{best} - X_{ij}(t-1)) + A \cdot C_2 \cdot \text{rand}(0,1) \cdot (g_{best} - X_{ij}(t-1)) \quad (9)$$

**Step 6:** Update the position of each particle in the swarm according to the following formula

$$X_{ij}(t) = X_{ij}(t-1) + V_{ij}(t) \quad (10)$$

**Step 7:** Update particle best position and global best position.

**Step 8:** Repeat the cycle again until maximum number of iteration is reached.

**Step 9:** When the number of iteration reaches its maximum value, then the latest global best position value is considered as the optimal value for the controller parameter.

## II. APPLICATIONS : LFC FOR TWO POWER SYSTEM AREAS

In electric power system, the generated power must be matched with consumed power instantaneously and continuously. Varying load demands in interconnected power system causes frequency deviation of the grid from the nominal values and interchanging tie line power between areas. Large frequency deviation can cause equipment damages, reduction in load performance and interference with system protection scheme [28] which may lead to system collapse. The rate of frequency deviation depends on the magnitude of generation and demand difference and the inertia of all the generators [29] and loads within the system. Frequency is tightly controlled under normal conditions and coordinated under all conditions [30]. The load frequency controller function is to minimize the transient deviation of the frequency and maintains their values to steady state values and to restore the scheduled interchanges between different areas [31].

The power system model selected [32] is for two different power system areas shown in Figure 1. Area 1 has two thermal steam turbines with reheaters and Area 2 has two thermal steam turbines with reheaters and one gas turbine. The power system area components are speed governor, turbine unit (reheat steam turbine or gas turbine) and generator.

**Only one scenario is applied for this model;**

**Case 1:** High loading percentage disturbance is applied to each area. -0.07 p.u. load throw is withdrawn from Area 1 and 0.15 p.u loading is added for Area 2.

### A1. Model 1 objective function

The control objective is to control the frequency deviation for each area, a decentralized AWPSO based PID controller has been implemented for each power system area. Error signal acts as an input to the controller. The performance indices (IAE, ISE and ITAE) are used as objective function [11-12]. The mathematical equations for the performance indices and the cost function are as follows:

**Area 1 IAE (Integral of Absolute Error for Area 1):**

$$IAE_1 = \int_0^{\infty} |e_1(t)| dt \quad (11)$$

**Area 2 IAE (Integral of Absolute Error for Area 2):**

$$IAE_2 = \int_0^{\infty} |e_2(t)| dt \quad (12)$$

**Area 1 ISE (Integral of Squared Error for Area 1):**

$$ISE_1 = \int_0^{\infty} e_1^2(t) dt \quad (13)$$

**Area 2 ISE (Integral of Squared Error for Area 2):**

$$ISE_2 = \int_0^{\infty} e_2^2(t) dt \quad (14)$$

**Area 1 ITAE (Integral of Time weighted Absolute Error for Area 1):**

$$ITAE_1 = \int_0^{\infty} t |e_1(t)| dt \quad (15)$$

**Area 2 ITAE (Integral of Time weighted Absolute Error for Area 2):**

$$ITAE_2 = \int_0^{\infty} t |e_2(t)| dt \quad (16)$$

**P<sub>tie</sub> IAE (Integral of absolute error for Tie line) :**

$$IAE_{P_{tie}} = \int_0^{\infty} |e_{P_{tie}}(t)| dt \quad (17)$$

**P<sub>tie</sub> ISE (Integral of squared error for Tie line):**

$$ISE_{P_{tie}} = \int_0^{\infty} e_{P_{tie}}^2(t) dt \quad (18)$$

**P<sub>tie</sub> ITAE (Integral of absolute error for Tie line):**

$$ITAE_{P_{tie}} = \int_0^{\infty} t |e_{P_{tie}}(t)| dt \quad (19)$$

The objective function is defined as follows:

**For IAE case:**

$$f = IAE_1 + IAE_2 + IAE_{P_{tie}} \quad (20)$$

**For ISE case:**

$$f = ISE_1 + ISE_2 + ISE_{P_{tie}} \quad (21)$$

**For ITAE case:**

$$f = ITAE_1 + ITAE_2 + ITAE_{P_{tie}} \quad (22)$$

The performance index shall be selected by the user.

### A2. Model 1 Parameters Values

The values of Model 1 parameters indicated in the block diagram in Figure 1 are listed in Table 1

Table 1: Model 1 Parameters values

System parameters	Value
Tg1, Tg2	0.08 seconds
Tt1, Tt2	0.3 seconds
Tl1, Tl2	20 seconds
Kl1, Kl2	120 Hz/MW p.u.
R1, R2	2.4 Hz/MW p.u.
B1, B2	0.425 MW p.u./ HZ
T12	0.545 MW p.u./ HZ
a12	1
Kr1Tr1, Kr2Tr2	5
Tr1, Tr2	10 seconds
dPL1	0.07 p.u.
dPL2	-0.15 p.u.
T1	10 seconds
T2	0.1 seconds
T3	3 seconds
D <sub>turb</sub>	0.03
R	0.05
KT	1
V <sub>max</sub>	0.8
V <sub>min</sub>	-0.8

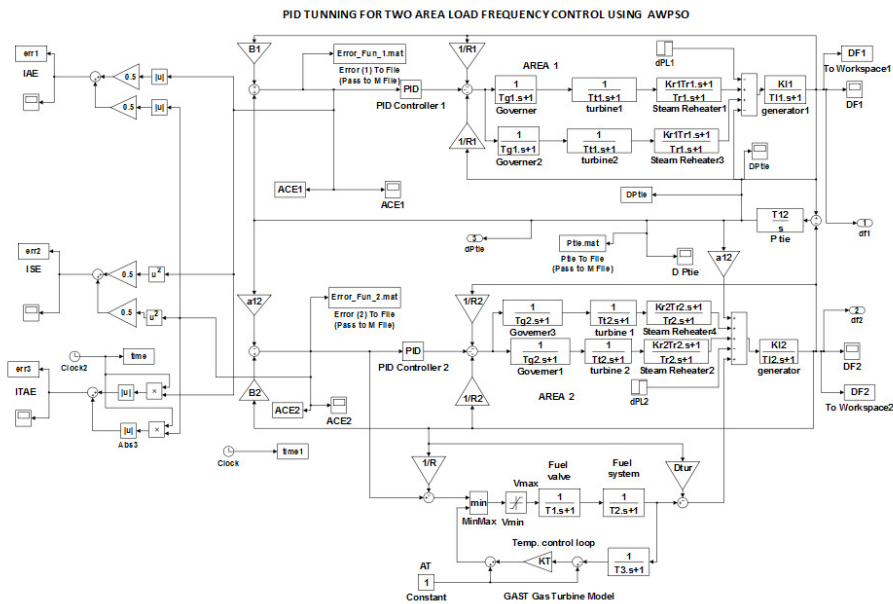

Figure 1: Model 1 Block Diagram

**A3. Simulation Results**

Simulation for Case 1 is applying loading of -0.07 p.u. load throw from Area 1 and 0.15 p.u. loading on Area 2. The purpose of case 1 is to check and prove the robustness and reliability of the proposed control scheme against high disturbances. In this case PID controller tuned with AWPSO is utilized.

Frequency deviation for Area 1 and 2 with IAE are as follows:

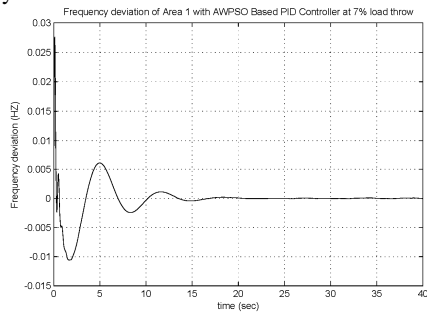

Figure 2: Frequency Deviation For Area 1 With PID-AWPSO Based on IAE

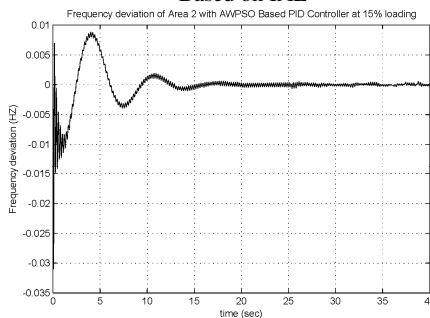

Figure 3: Frequency Deviation For Area 2 With PID-AWPSO Based on IAE

The simulation values for IAE, ISE, and IATE cases are mentioned in Table 2, and 3 for the proposed WPSO as compared with the PSO algorithms.

Figures for the frequency deviation of Area 1 and 2 with ISE using AWPSO are as follows:

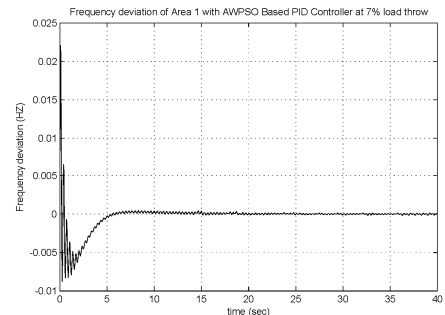

Figure 4: Frequency Deviation For Area 1 With PID-AWPSO Based on ISE

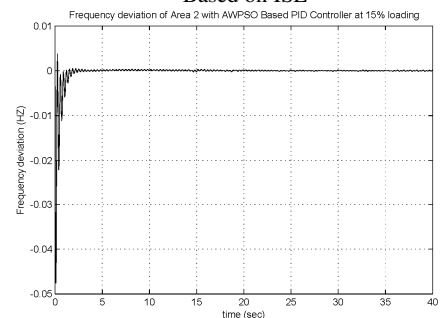

Figure 5: Frequency Deviation For Area 2 With PID-AWPSO Based on ISE

Table 2 : Simulation results values using AWPSO

	IAE	ISE	ITAE
Settling time-Area1 (sec.)	5.6	6.2	6.61
Settling time-Area2 (sec.)	3.7	5.2	5.27
Settling time-Tie line (sec.)	17.4	12	22.1
$K_{p1}$	3.89	9.45	3.62
$K_{i1}$	9.42	6.07	2.05
$K_{d1}$	3.53	3.50	2.81
$K_{p2}$	6.49	2.56	4.45
$K_{i2}$	2.96	2.64	2.70
$K_{d2}$	3.68	4.79	2.05

Table 3 : Simulation results values using PSO

	IAE	ISE	ITAE
Settling time-Area1 (sec.)	18.9	14.11	12.46
Settling time-Area2 (sec.)	13.4	7.29	12.31
Settling time-Tie line (sec.)	19.0	14.36	23.93
$K_{p1}$	8.95	4.46	8.85
$K_{i1}$	3.11	8.29	1.43
$K_{d1}$	9.06	9.33	4.06
$K_{p2}$	5.01	4.06	0.94
$K_{i2}$	8.94	7.56	6.92
$K_{d2}$	7.13	3.88	5.23

Frequency deviation for Area 1 and 2 with ITAE are as follows:

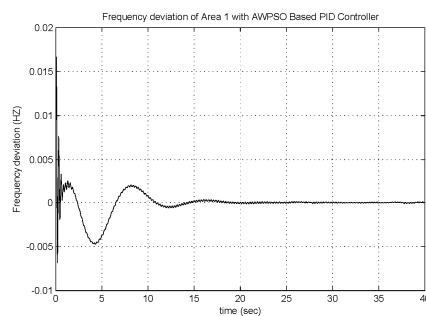

Figure 6: Frequency Deviation For Area 1 With PID-AWPSO Based on ITAE

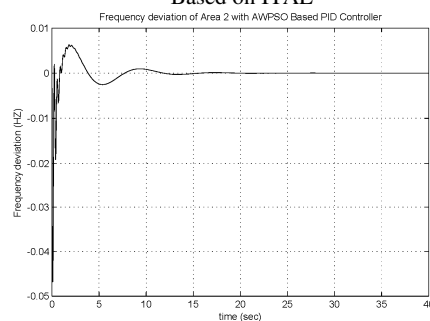

Figure 7: Frequency Deviation For Area 2 With PID-AWPSO Based on ITAE

#### A4. Model 1 AWPSO Parameters for Case 1

The chosen AWPSO parameters values for Model 1 are mentioned in Table 4.

Table 4: Model 1 AWPSO Parameters

parameters	Value
$N$	25 particles
$n$	100 iterations
$d$	6 variables
$C_1$	2
$C_2$	2
$W_o$	0.15
$A_o$	0.5
$X_{orange}$	[0 10]

#### A5. Summary for Case 1 Simulation

From the simulation results for Case 1, we will find the undershoot value within the permissible range (+/-0.5Hz). The minimum settling time achieved with ISE performance index. The paper main contributions may be summarized as follows:

- 1) The introduction of a reliable AWPSO evolutionary algorithm as a tuning tool for the PID controller in a non-linear applications.
- 2) The consideration of the nonlinearity in the load frequency control (LFC) of electric power systems.
- 3) The implementation of the distributed generation (DG) sources in the multi areas application of LFC.

### III. DISCUSSION AND CONCLUSION

This paper presents a design for PI/PID controller tuned with Adaptive Weighted Particle Swarm Optimization (AWPSO) algorithm. This control approach proved its efficient performance through application on load frequency control of electric power system.

For the selected model, it is clear that the proposed control approach is capable of reducing settling time with a measurable value. The systems response shows that the proposed control approach is reliable and robust without reliance on system models. The difficulties faced in utilizing AWPSO was choosing the appropriate AWPSO parameters to suit each model in the presence of non-linearity in systems models. In addition to specifying the suitable objective function for each model along with the controller gains.

### REFERENCES

- [1] A. Salami, S. Jadid, and N. Ramezani, "The Effect of load frequency controller on load pickup during restoration," *1st International Power and Energy Conference, PECON 2006*, pp. 225-228, 2006.
- [2] H.S. Moghanlou and H.A. Shayanfar, "Robust decentralized LFC design in a restructured power system," *International Journal of Emerging Electric Power Systems*, vol. 6. no. 2, Art. 4, 2006.
- [3] Y. Wang, R. Zhou and C. Wen "Robust Load Frequency Controller Design For Power Systems" IEE Proceedings C. Generation, Transmission and Distribution. Vol. 140, No. 1. - 1993. - pp. 11-16.
- [4] H. Shayeghi, H.A. Shayanfar b, A. Jalili "Load Frequency Control Strategies A State Of The Art Survey for The Researcher "Energy Conversion and Management Journal. - 2009. - pp. 344-353.
- [5] C.S. Chang and W. Fu "Area load frequency control using fuzzy gain scheduling of PI controllers," *Electrical Power and Energy Systems*, vol. 42, no. 2, pp. 145-152, 1997.
- [6] Bevrani Hassan "Robust Power System Frequency Control" [Book]. - Brisbane, Australia : Springer Science + Business Media, LLC, 2009.

- [7] P. Kundur "Power System Stability And Control " [Book]. - New York : McGraw-Hill, 1994.
- [8] Kazemi, Ahad and Amini, Arman "Lead/Lag SSSC Based Controller for Stabilization of Frequency Oscillations in Multi-Area Power System" 20th International Power System Conference. - Tehran- Iran : 98-E-PSS-148, 2005. - pp. 1-9.
- [9] V.D.M. Kumar, "Intelligent controllers for automatic generation control," IEEE Region 10 International Conference on Global Connectivity in Energy, Computer, Communication and Control, TENCON '98, vol. 2, pp. 557-574, 1998.
- [10] A. Ismail, "Improving UAE power systems control performance by using combined LFC and AVR," The Seventh U.A.E. University Research Conference, ENG., pp. 50-60, 2006.
- [11] Mohamed. M .Ismail M. A. Mustafa Hassan, " Load Frequency Control Adaptation Using Artificial Intelligent Techniques for One and Two Different Areas Power System", International Journal of Control, Automation and Systems VOL. 1, NO. 1, January 2012
- [12] M. A. Tammam , " Multi Objective Genetic Algorithm Controller's Tuning for load Frequency Control In Electric Power systems ", M. Sc., Cairo University, 2011
- [13] S.P. Ghoshal "Multi-area Frequency and Tie-line Power Flow Control with Fuzzy Logic Based Integral Gain Scheduling" Journal-EL, Vol 84. - 2003.
- [14] Mathur H.D. and Manjunath H.V. "Frequency Stabilization using Fuzzy Logic Based Controller for Multi-area Power System" The South Pacific Journal of Natural Science. - 2007. - pp. 22-30.
- [15] R. Shankar Naik, K. Chandra Sekhar, K. Vaisakh "Adaptive PSO Based Optimal Fuzzy Controller Design for AGC Equipped with SMES and SPSS", Journal of Theoretical and Applied Information Technology. pp. 8 - 16.
- [16] M. A. Tammam, M. A. Moustafa, M. A. E. S. Aboelela and A. E. A. Seif " Load Frequency Control Using Genetic Algorithm Based PID Controller For Single Area Power System "International 12 5 Conference on Renewable Energies and Power Quality (ICREPQ'11). - Las Palmas de Gran Canaria (Spain), 2010.
- [17] Abd-Elazim S.M and Salim E. Ali " Optimal PID Tuning for Load Frequency Control Using Bacteria Foraging Optimization Algorithm", 14th International Middle East Power Systems Conference (MEPCON'10). - Cairo – Egypt, Cairo University, 2010. - pp. 410 - 415.
- [18] Haluk GÖZDE1 M. Cengiz TAPLAMACIOĞLU2, İlhan KOCAARSLAN and Ertugrul ÇAM "Particle Swarm Optimization Based Load Frequency Control in A Single Area Power System" University Of Pitesti – Electronics and Computers Science, Scientific Bulletin, No. 8, Vol. 2. - 2008. - pp. 106-110.
- [19] Kennedy.J and Russell C. Eberhart, "Swarm Intelligence", Morgan-Kaufmann, pp 337-342, 2001.
- [20] Eberhart, R. C. and Kennedy. J, "A new optimizer using particle swarm theory", Proceeding of the Sixth International Symposium on Micro Machine and Human Science. Nagoya, Japan, pp. 39-43, 1995.
- [21] Kennedy, J. and Eberhart, R. C, "Particle swarm optimization", Proc. IEEE Int'l conf. on Neural Networks, Piscataway, NJ: IEEE Press, IV pp.1942-1948, 1995.
- [22] Zwe-Lee Gaing, "A Particle swarm optimization approach for optimum design of PID controller in AVR system", IEEE Transactions on Energy Conversion, 19:384 – 391, 2004.
- [23] S. N. Sivanadam, P. Visalakshi, "Multiprocessor using Hybrid Particle swarm optimization with Dynamically Varying inertia", International Journal of computer science and applications, PP 95-106, 2007.
- [24] Mahfouf, M., Minyou-Chen, D. A. Linkens, "Adaptive Weighted Particle Swarm Optimization (AWPSO) of Mechanical Properties of Alloy Steels", 8th International Conference on Parallel Problem Solving from Nature (PPSN VIII), Birmingham (U.K), 2004.
- [25] Xiaohui Hu, Russel Eberhart, Yuhui shi, "Recent advances in particle swarm", Proceeding of the congress on evolutionary computation (CEC-2004), Vol. 1, Piscataway, IEEE Service Center, pp. 90-97, 2004.
- [26] K.sabahi, A. sharifi, M. Aliyari, M. Teshnehlab and M. Aliasghary, "Load frequency control in interconnected power system using Multi-objective PID controller", Journal of Applied Sciences, pp. 1-7, 2008.
- [27] C. Agees Kumar, N. Kesavan Nair, "Multi-objective PID Controller based on Adaptive Weighted PSO with Application to Steam Temperature control in Boilers", International Journal of Engineering Science and Technology, 2010.
- [28] Hassan Bevrani, "Robust Power System Frequency Control", Springer, New York, USA, 2009.
- [29] Angelo Baggini, "Handbook of power quality", Wiley, England, 2008.
- [30] B. Kirby, J. Dyer, C. Martinez, R. Shoureshi, R. Dagle, "Frequency Control Concerns In The North American Electric Power System", ORNL/TM 2003/41, Oak Ridge National Laboratory, Oakridge TN, December 2002.
- [31] Goran Andersson, "Dynamics and Control of Electric Power Systems", EEH – Power systems laboratory, February 2011.
- [32] R. Jayanthi, I. A. Chidambaram, C. Bansuri, "Decentralized controller gain scheduling using PSO for power restoration assessments in a two area interconnected power system", International Journal of Engineering, Science and Technology, PP.14-26, 2011.