

# Estimation of calcified tissues hardness via calcium and magnesium ionic to atomic line intensity ratio in laser induced breakdown spectra <sup>☆</sup>

Z.A. Abdel-Salam <sup>a</sup>, A.H. Galmed <sup>a</sup>, E. Tognoni <sup>b</sup>, M.A. Harith <sup>a,\*</sup>

<sup>a</sup> National Institute of Laser Enhanced Science (NILES), Cairo University, Giza, Egypt

<sup>b</sup> Applied Laser Spectroscopy Laboratory, IPCF/CNR, Pisa, Italy

Received 26 November 2006; accepted 12 October 2007

## Abstract

Calcified tissues representing three different matrices, namely enamel of human teeth, shells and eggshell, have been studied via Laser Induced Breakdown Spectroscopy (LIBS) technique. The experimental CaII/CaI and MgII/MgI ratios have been measured, in view of the expected correlation between the extent of ionization caused by the laser induced shock wave (SW) and the hardness of the target. The ratio CaII/CaI between the ionic calcium line at 373.69 nm and the neutral line at 428.9 nm is obtained for enamel, shells and eggshell spectra, as well as the ratio MgII/MgI between the ionic magnesium line at 280.26 nm and the neutral line at 285.22 nm. The results show that such spectral lines intensities ratio differs for different matrices and is indeed related to the target materials hardness. It is also found that the MgII/MgI ratio is preferable as an indicator of hardness since these lines are less affected by self absorption. The SW front speed has been measured in the three cases and the obtained values confirm the proportionality to the target hardness. The results here obtained suggest the feasibility of the quantitative estimation of hardness for any other calcified tissues.

© 2007 Elsevier B.V. All rights reserved.

**Keywords:** Calcified tissues; Hardness; LIBS; Shock waves

## 1. Introduction

Calcified tissues, e.g. bones, teeth, shells and eggshell, have been found to be excellent “archives” related to nutrition and exposure to changing environmental conditions. Calcium is the major element in all such tissues with a percentage concentration of normally more than 90%. However, the existing other minor elements as well as the crystalline structure affect the general physical properties of different calcified tissues, e.g. its hardness, surface roughness, color, optical properties...etc. Laser induced breakdown spectroscopy (LIBS) has been used successfully for the qualitative and quantitative elemental analysis of the enamel and dentin of human teeth [1–3] and human bones too [1]. Measurement of the demineralization of teeth enamel and dentin and follow up of trace elements relevant

to the environmental and dietary habits are among the applications of LIBS. The simplicity and easiness of the LIBS technique in addition to its other advantages compared with other conventional elemental analysis techniques made it viable in such field. Moreover, it has been shown that the technique is promising for in vivo measurements in the future [1,2].

It has been shown that the atomic emission spectrum of a given element obtained in a LIBS experiment differs for different solid matrices [4] (matrix effect). It is well known that the shock wave plays an important role in the production of luminous plasma, especially when the plasma is produced under atmospheric pressure [5–7]. In a recent study focused on concrete, Tsuyuki et al. [8] reported that the intensity ratio of ionic to atomic line of calcium (CaII/CaI) is proportional to the target material compressive strength. The phenomenon is interpreted as an effect mediated by the laser induced shock wave. The authors mentioned that, for a soft sample, the speed of the shock wave would be slowed down in comparison to the case of a hard target, due to the lack of a repulsive force on the irradiated surface, resulting in a reduction of the ionization effectiveness and then of the ionic to neutral intensity ratio.

<sup>☆</sup> This paper was presented at the 4th International Conference on Laser Induced Plasma Spectroscopy and Applications (LIBS 2006) held in Montreal, Canada, 5–8 September 2006, and is published in the Special Issue of Spectrochimica Acta Part B, dedicated to that conference.

\* Corresponding author. Fax: +202 35675335.

E-mail address: mharithm@niles.edu.eg (M.A. Harith).

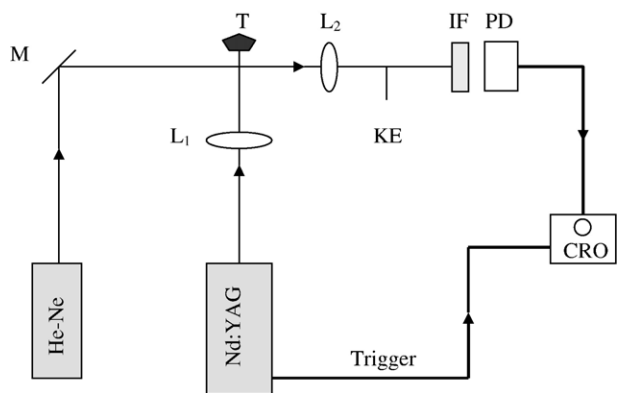

Fig. 1. Diagram of the experimental setup used. M is a mirror, T the target,  $L_1$  and  $L_2$  are two focusing lenses, KE is a knife edge, IF is an interference filter, PD is a fast photodiode, and CRO is an oscilloscope.

According to these results obtained for different samples of concrete, it is expected that the measurement of ionic to neutral lines ratio from Ca (or other elements of the target) would allow estimating calcified tissues hardness.

The aim of the present paper is to evaluate the feasibility of the measurement, via LIBS technique, of the hardness of calcified tissues. Three different calcified tissues have been included in the study: teeth enamel, shells, and eggshell. From each kind of tissue, the atomic emission spectra have been obtained and the ratios of ionic to neutral lines have been calculated for calcium and magnesium. The hardness has been measured by a mechanical tester. A simple experimental procedure using a HeNe laser has been employed to probe the expanding laser induced shock wave.

## 2. Experimental

The laser, spectrometer and detector used for the LIBS measurements, integrated in the Modi system, are described in details elsewhere [9,10]. The used source is a Q-switched Nd:YAG laser, operating at the fundamental wavelength ( $\lambda=1064$  nm), with a pulse duration of 12 ns (FWHM), that can be operated in single and double pulse regimes. For the present experiment, the pulse energy was set to 50 mJ and the repetition rate to 1 Hz. The targets used in the LIBS experiments were 10 clean and sound samples from each type of the investigated calcified tissues. The laser beam was focused on the samples using a 10-cm focal length lens. The target was mounted on an X–Y micrometric translation stage, remotely controllable by a personal computer. The plasma optical emission was collected by a quartz optical fiber with diameter of 1 mm held at a distance of 2 cm above the plasma at an angle of  $30^\circ$  with respect to the target surface. The collected plasma emission is then fed via the optical fiber to the echelle spectrometer coupled to the ICCD for dispersion and detection. The obtained spectra are displayed and stored on a personal computer for further processing and analysis. The same pc was used to control the delay between the laser firing time and the spectral acquisition time, as well as the duration of the acquisition gate. The ICCD was triggered optically at a typical delay time of  $2 \mu\text{s}$  and gate width  $2 \mu\text{s}$ . The analysis of the emission spectra was accomplished using the LIPS<sup>+</sup> software [11,12].

A simple experimental setup is used to probe the laser induced shock wave (SW), Fig. (1). Another compact Q-switched Nd:YAG laser (Brio, Quantel — France) operating at its fundamental wavelength ( $\lambda=1064$  nm) is used to obtain shock waves following the breakdown onto the target surface. The laser pulse energy was 50 mJ with pulse duration 5 ns (FWHM) at 10 Hz repetition rate. Laser light is focused by a quartz aspheric lens ( $L_1$  in Fig. 1) of focal length 10 cm onto the target surface in air at atmospheric pressure. The incident laser energy is monitored via a standard Joule meter (not shown in Fig. 1). The laser induced propagating SW is probed using a HeNe laser beam passing parallel to the target surface and 5 mm apart from it. The HeNe beam is focused by a lens  $L_2$  on the edge of a knife edge KE then passes through an interference filter IF to avoid the strong scattering of the YAG

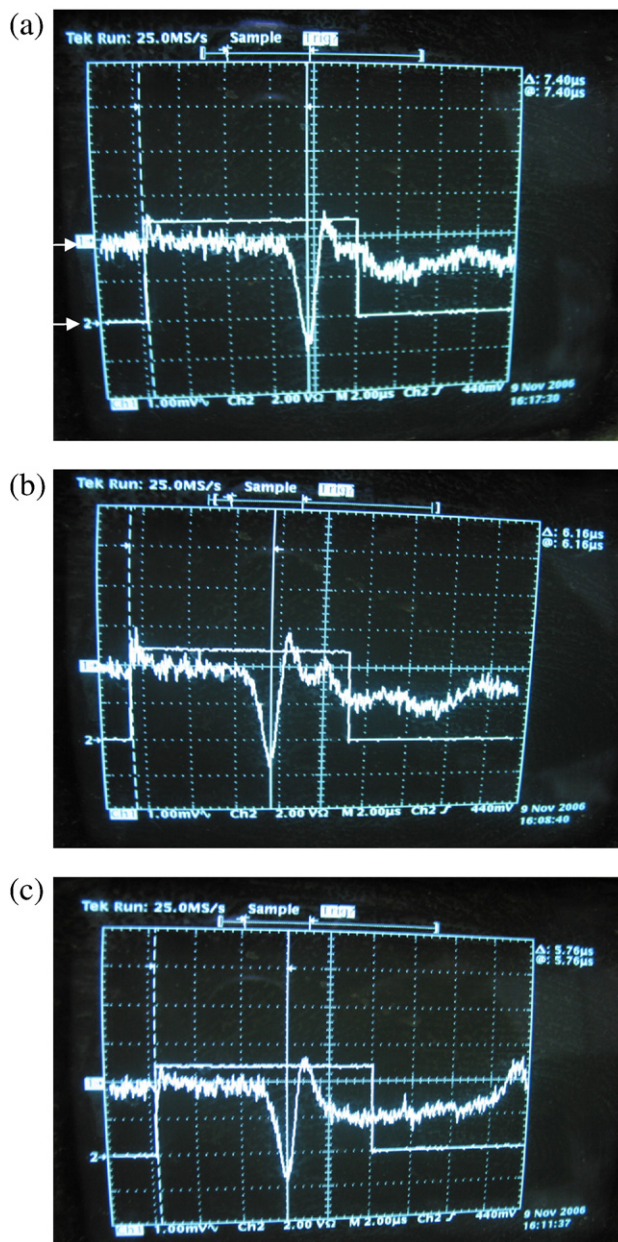

Fig. 2. Typical photodiode signal of (a) eggshell (b) shell and (c) enamel. Trace 1 is the HeNe signal and trace 2 is the trigger signal.

laser in front of the photodiode, which is connected to a storage oscilloscope CRO. When the SW crosses the HeNe probe, the intensity of the light impinging on the photodiode drops. The time spent by the SW front to travels the 5 mm distance is measured as the interval between the trigger to the CRO (taken from the Q-switch of the laser) and the appearance of the negative pulse. In doing this, it is assumed that the Q-switch pulse and the formation of the SW are coincident in time; actually, a delay of about 100 ns may be expected between the two events, which is negligible compared to the measured intervals (of several  $\mu\text{s}$ ). In this way, it is very easy to measure the average velocity of the SW at 5 mm from the target surface [13]. Fig. 2a, b and c shows typically detected signals for the three different calcified tissues.

To measure experimentally the hardness of the investigated calcified tissues a Shimadzu Micro hardness tester type M was used, which provides the Vickers hardness number (VHN) for the material investigated. The hardness number is defined as the ratio of the load applied to the indent (a square-based diamond pyramid with a  $136^\circ$  included angle between opposite faces) divided by the area of the impression. [14]

### 3. Results

Fig. 3 shows the results of microhardness measurements for the enamel, shell and eggshell. The differences in the hardness between the three types of calcified tissues are clear and the enamel, for example, is twice as hard as the shell.

The LIBS spectra obtained from the 10 samples of each type have been normalized on the strong carbon line at 247.8 nm to compensate for any experimental fluctuations. The spectral lines are identified and labeled in all spectra of different samples. The ratio CaII/CaI between the ionic calcium line at 373.69 nm and the neutral line at 428.9 nm is calculated for enamel, shells and eggshell spectra. The ratios obtained are the average of 10 values obtained from the spectra acquired for the ten different samples of each kind.

The histogram in Fig. 4 shows the calcium lines ratio for the investigated targets. Fig. 5 depicts the relation between the CaII/CaI ratio and the corresponding hardness measured by Vickers test. It may be worth to mention that, since the lines of calcium have relatively high self absorption cross section [15] and calcium

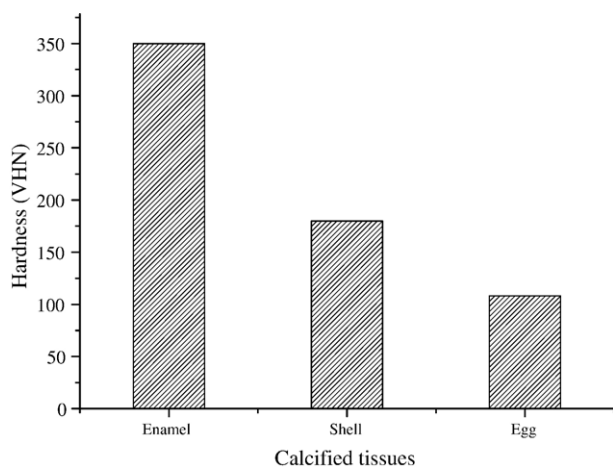

Fig. 3. The hardness (VHN) of different calcified tissues.

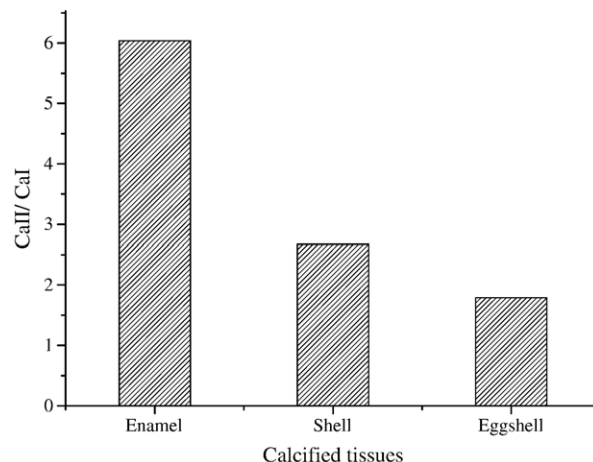

Fig. 4. CaII 373.69 nm/CaI 428.9 nm for different calcified tissues.

is the host element in all the three investigated types of calcified tissues with concentrations higher than 95%, strong self absorption effect on the lines intensity is expected. The partial self absorption coefficient [16]  $K_R(\lambda)$  in  $\text{m}^2 \text{s}^{-1}$  for a spectral line can be obtained by multiplying the self absorption cross section of such line ( $S_L$ ) by the lower energy level population ( $C$ ):

$$K_R(\lambda) = S_L \cdot C$$

Where:

$$S_L = 0.330 \lambda_0^3 \sqrt{\frac{M}{T}} \frac{g_j}{g_i} A_{ji}$$

and  $C$  is given by:

$$C = (g_j A_{ji} / U) \text{Exp}(-E_i / kT)$$

$\lambda_0$  is the wave length of the spectral line in meter,  $T$  is the temperature in Kelvin and  $A_{ji}$  is the transition probability in  $\text{s}^{-1}$ ,

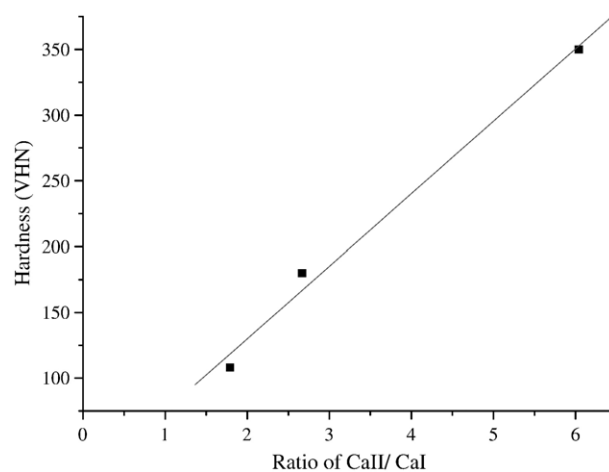

Fig. 5. The correlation between the hardness of calcified tissue and the intensity ratio of CaII 373.69 nm and CaI 428.9 nm emission lines. The hardness of the calcified tissues was measured by means of a mechanical tester in (VHN). The points are the measured values and the line is the linear fitting,  $R=0.9954$ .



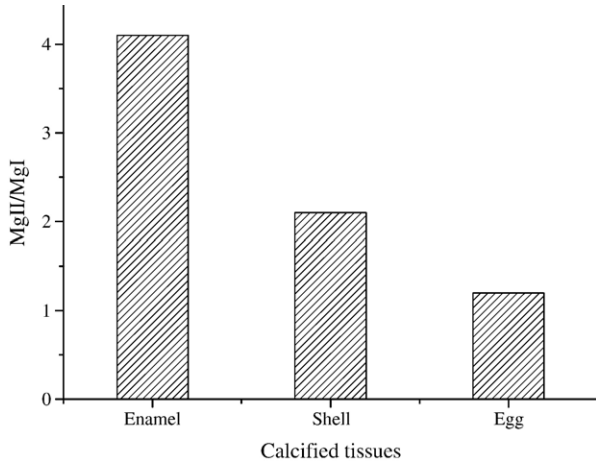

Fig. 6. MgII 280.26 nm/MgI 285.22 nm for different calcified tissues.

$M$  is the atomic mass of the element,  $g_i$  and  $g_j$  are the statistical weights of the lower and upper levels respectively,  $U$  is the partition function,  $E_i$  is the energy of the lower energy level and  $k$  is Boltzmann's constant.

In principal, it is easy to calculate both parameters  $S_L$  and  $C$ , so a partial self absorption coefficient has been calculated for each line [17]. The two calcium lines chosen in our measurements have relatively low partial self absorption coefficient  $K_R(\lambda)$ . For Ca II at 373.69 nm, and Ca I at 428.9 nm  $K_R(\lambda)=2.5001E-7$  and  $5.0078E-7 \text{ m}^2 \text{ s}^{-1}$  respectively. These values may be compared with the strongly self absorbed lines used by K. Tsuyuki et al. [8] which are CaII at 396.8 nm and CaI at 422.6 nm where  $K_R(\lambda)=1.9618 E-5$  and  $9.6607E-5 \text{ m}^2 \text{ s}^{-1}$  respectively. In addition, the two lines used in our case are non-resonant lines contrary to the lines used by the same mentioned authors [8].

The above measurements and calculations have been repeated adopting a minor element in the calcified tissues, namely the magnesium. The lines Mg II at 280.26 nm and Mg I at 285.22 nm are chosen, in view of their expected optical

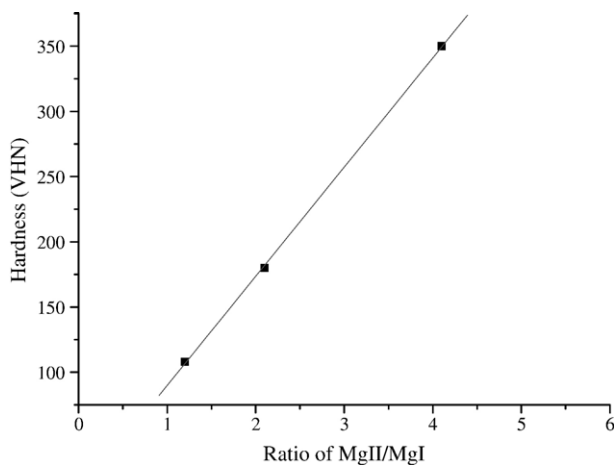

Fig. 7. The correlation between the hardness of calcified tissue and the intensity ratio of MgII 280.26 nm and MgI 285.22 nm emission lines. The hardness of the calcified tissues was measured by means of a mechanical tester in (VHN). The points are the measured values and the line is the linear fitting,  $R=0.9999$ .

Table 1

The relation between Calcified tissues hardness  $H$ , and ionic to atomic line intensity ratio in case of calcium and magnesium

Calcified tissues	H	CaII/CaI	MgII/MgI
Enamel/eggshell	3.24	2.99	3.38
Enamel/shell	1.94	2.26	1.95
Shell/eggshell	1.66	1.32	1.73

thinness [18]. Although these two spectral lines are resonant lines but the effect of self absorption in case of such lines is well compensated by the low abundance of the magnesium in all the three investigated target materials. The histogram in Fig. 6 shows the values of the ratio MgII/MgI obtained for the different materials under study. Fig. 7 shows the proportionality between hardness values and the MgII/MgI ratio. The trend of the obtained straight line is nearly the same as in case of CaII/CaI with some what higher value of the slope. The differences between the calcium and magnesium cases may be due to the relatively high self absorption in case of calcium.

Table 1 shows the relation between calcified tissues hardness  $H$ , and ionic to atomic line intensity ratio in case of calcium and magnesium. The  $H$  ratios are in very good agreement with the MgII/MgI ratios than that of CaII/CaI ratios. This demonstrates the self absorption effect on the calcium measurements.

Therefore, it is better to use minor element such as the magnesium than the major element if we want to have accurate estimation of the target material hardness. However, for qualitative comparison between the hardness of different calcified tissues the ratio CaII/CaI may be also successfully used, after a careful choice of the lines.

As mentioned before, the measurements of CaII/CaI in case of concrete have been interpreted in view of the laser induced shock wave, which is stronger for harder materials than for softer ones [7,8]. To confirm the relation between the target material hardness and the strength of the laser induced shock wave, we measured directly the average speed of the expanding wave front adopting the experimental setup in Fig. 1. The results of the SW front speed measurements on calcified tissues are in good agreement with the above mentioned interpretation

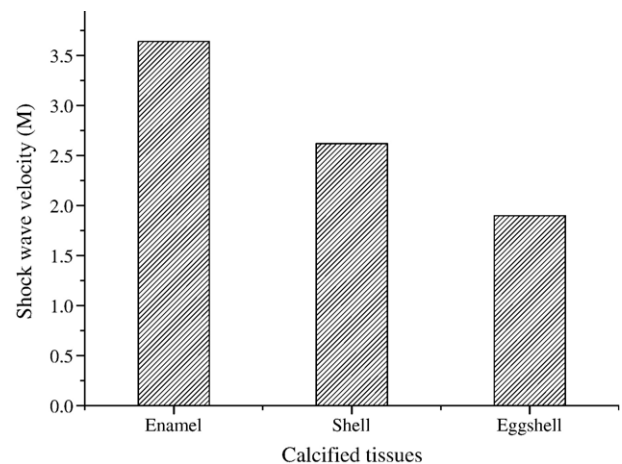

Fig. 8. The speed of the laser induced shock wave front at 5 mm from the surface of different calcified tissues.

developed for concrete. In fact, the measured speeds of the SW front shown in the histogram in Fig. 8 were 3.6, 2.62 and 1.9 Mach for enamel, shells and eggshells respectively, i.e. the harder the target, the faster the shock wave.

#### 4. Conclusion

In conclusion, using LIBS technique in the present study we have successfully demonstrated a simple method for the qualitative and quantitative estimation of calcified tissues hardness. This method depends on the role of the laser induced shock wave on the ionization rate of the ablated target material atoms. The ratio of CaII/CaI and MgII/MgI is found to be proportional to the target material hardness. Depending on the material composition, it may be preferable to exploit the MgII/MgI to avoid any underestimation of the target hardness due to the strong self absorption in case of calcium spectral emission lines. The measured shock wave front speeds in case of the three investigated calcified tissues confirm that the harder the target the higher the SW front speed. So it has been shown that it is feasible to make use of the LIBS with its advantages as an elemental analysis technique for the estimation of the calcified tissues hardness.

#### References

- [1] O. Samek, D.C.S. Beddows, H.H. Telle, J. Kaiser, M. Liska, J.O. Caceres, A. Gonzales, Urena, Quantitative laser induced breakdown spectroscopy analysis of calcified tissues samples, *Spectrochim. Acta Part B* 56 (2001) 865–875.
- [2] N.A. Khattab, The effect of environment on teeth of Egyptian Nubians and Ugandans: an anthropological comparative study. PhD thesis, Institute of African Research and Studies, Cairo Univ. (2003).
- [3] S. A. El-Tayb, Laser elemental analysis of ancient Egyptians teeth. MSc thesis, National Institute of Laser Enhanced Sciences (NILES), Cairo Univ. (2006).
- [4] M.A. Ismail, H.M. Imam, A.R. Elhassan, M.A. Harith, LIBS limit of detection and plasma parameters of some elements in two different metallic matrices, *J. Anal. At. Spectrom* 19 (2004) 489–489.
- [5] S.H. Jeong, R. Greif, R.E. Russo, Shock wave and material vapor plume propagation during excimer laser ablation of aluminum samples, *J. Phys. D: Appl. Phys.* 32 (1999) 2578–2585.
- [6] R. Krasniker, V. Bulatov, I. Schechter, Study of matrix effects in laser plasma spectroscopy by shock wave propagation, *Spectrochim. Acta Part B* 56 (2001) 609–618.
- [7] A.M. Marpaung, R. Hedwig, M. Pardede, H. Kurniawan, M.O. Tiia, K. Kagawa, Shock wave plasma induced by TEA CO<sub>2</sub> laser bombardment on glass samples at high pressures, *Spectrochim. Acta Part B* 55 (2000) 1591–1599.
- [8] K. Tsuyuki, S. Miura, N. Idris, K. Hendrik, T. Jie, K. Kagawa, Measurements of concrete strength using the emission intensity ratio between Ca II 396.8 nm and Ca I 422.6 nm in a Nd:YAG laser induced plasma, *Appl. Spectrosc.* 60 (2006) 61–64.
- [9] M.A. Ismail, G. Cristoforetti, S. Legnaioli, L. Pardini, V. Palleschi, A. Salvetti, E. Tognoni, M.A. Harith, Comparison of detection limits, for two metallic matrices, of laser induced breakdown spectroscopy in the single and double pulse configurations, *Anal. Bional. Chem.* 385 (2006) 316–325.
- [10] K. Amal, S.H. Elnaby, V. Palleschi, A. Salvetti, M.A. Harith, Comparison between single and double pulse LIBS at different air pressures on silicon target, *Appl. Phys.*, B 83 (2006) 651–657.
- [11] A. Ciucci, M. Corsi, V. Palleschi, S. Rastelli, A. Salvetti, E. Tognoni, New procedure for quantitative elemental analysis by laser induced plasma spectroscopy, *Appl. Spectrosc.* 53 (1999) 960–964.
- [12] M. Corsi, G. Cristoforetti, V. Palleschi, A. Salvetti, E. Tognoni, A fast and accurate methods for the determination of precious alloys caratage by laser induced plasma spectroscopy, *Eur. Phys. J D* 13 (2001) 373–377.
- [13] A.M. Azzeer, A.S. Al-Dwayyan, M.S. AL-Salhi, A.M. Kamal, M.A. Harith, Optical probing of laser induced shock waves in air, *App.phys. B* 63 (1996) 307–310.
- [14] N. Meredith, D. Sherriff, D.J. Setchell, S.A.V. Swenson, Measurements of the microhardness and Young's modulus of human enamel and dentin using an indentation technique, *Arch. Oral Biol.* 41 (1996) 539–545.
- [15] A.P. Thorne, Emission and absorption of line radiation, in: A.P. Thorne (Ed.), *Spectrophysics*, 2nd Ed, Chapman and Hall, London, 1988, p. 287, Ch.11.
- [16] T. Nelis, R. Payling, *Glow Discharge optical Emission Spectroscopy: A Practical Guide*, RSC, Cambridge, 2004.
- [17] R. Payling, P.L. Larkins, *Optical Emission Lines of the Elements*, Wiley, Chichester, 2000.
- [18] B. Le Drogoff, J. Margot, M.M. Chaker, M. Sabsabi, O. Barthelemy, T.W. Johnston, S. Laville, F. Vidal, Y. von Kaenel, Temporal characterization of femtosecond laser pulses induced plasma for spectrochemical analysis of aluminum alloys, *Spectrochim. Acta Part B* 56 (2001) 987–1002.