

Laboratory Investigation of Microbial Enhanced Oil Recovery

**M.S. Al-Blehed, M.H. Sayyoub, H.A. Shoeb, A.M Awwad
S.M. Desouky and A.M. Hemeida**

*Petroleum Engineering Department, College of Engineering, King Saud University,
P.O. Box 800, Riyadh 11421, Saudi Arabia*

(Received 11/5/1994; accepted for publication 21/6/1995)

Abstract. Twelve bacterial strains were isolated from Saudi crude oils and formation waters. Experimental work was conducted to identify the bacterial isolates, determine the compositions of the appropriate nutrients and carry out surface phenomena measurements. Based on the results obtained, three bacterial strains (O_{12} , O_{na} , O_q) were selected for displacement tests.

The effects of nutrient type, bacterial type, permeability, API and salinity on oil recovery were investigated. Results show that the bacterial strains O_{12} and O_{na} were found to produce biogases and biosurfactants. Biopolymers were produced by O_q . The greatest oil recovery was obtained from activation of the indigenous bacteria by 1% molasses concentration. Injection of the bacterial strains O_q and O_{na} in glucose or sucrose media resulted in a higher recovery of oil. No effects on oil recovery was observed upon changing permeability from 453 to 3736 md and salinity from 4.2 to 10% of total dissolved salt.

Introduction

Microbial enhanced oil recovery (MEOR) technology is the process of introducing or stimulating viable microorganisms in an oil reservoir for the purpose of enhancing oil recovery. Bacteria are the only microorganisms that have been proposed for enhanced oil recovery processes. They are small in size, grow exponentially and produce metabolic compounds such as gases, acids, surfactant and polymers. Bacteria also tolerate harsh environments, such as high formation water salinity, high pressure and high temperature.

In 1983, Bubela [1] found that the optimum metabolic temperature and rate of growth of rod-shaped bacteria increased with an increase in pressure. Moses and

Springham [2] (1982) observed that bacteria have been found to be catalytically active at high pressure. Grula *et al.* [3] (1983) readily grew clostridium in up to 75000 ppm salt concentrations.

The earliest realization that bacteria are beneficial to the production of oil was suggested by Backman [4] (1926). Zo Bell [5] (1946) presented a process for the secondary oil recovery using anaerobic, sulfate reducing bacteria *in situ*. Zo Bell [6] (1953) used other types of bacteria to enhanced oil recovery in laboratory tests.

In 1963, Kuznetsov *et al.* [7] found that bacteria discovered in some oil reservoirs in the Soviet Union produced 2 gm of CO₂ per day per ton of rock. Later, Synyukov *et al.* [8] (1970) employed microorganisms to aid the recovery of oil.

The laboratory study of specific microorganisms is done either for the surface production of various compounds or for the injection of cells into a reservoir for *in situ* production of metabolic compounds. Both will enhance oil recovery. Grula *et al.* [9] (1985) carried out laboratory tests to isolate salt-tolerant strains of some type of bacteria and then conducted field tests using them. Donaldson and Grula [10] (1985) found that some species of bacteria produce emulsifiers in salt concentrations up to 75000 ppm. Laboratory results of Torbati *et al.* [11] (1986) showed that the larger pores of Berea sandstone are plugged by the bacteria which caused a reduction of permeability leading to increasing oil recovery due to improvement in mobility ratio. Another laboratory research conducted by Bryant and Douglas [12] (1987) presented crude oil displacement mechanisms by microorganisms.

A review of many field applications of MEOR was presented by Bryant *et al.* [13] (1989). Bryant [14] (1991) found that MEOR screening criteria fit 27% of United States oil reservoirs. Recently MEOR field applications were presented in the proceeding of the international conference on MEOR edited by Donaldson [15] (1990). Hitzman [16] (1987) recently published a review on MEOR field testing.

Although several attempts [17-22] have been made to describe the MEOR process, no model has yet fully incorporated all factors that strongly affect the mechanisms of oil displacement, growth and transport of bacteria in porous media.

The main objectives of this study were to separate and classify bacteria that can be obtained from Saudi crude oils and formation waters and carry out displacement tests to investigate the effect of nutrient, bacteria type, permeability, salinity and API gravity on displacement efficiency.

This study is an original contribution to Saudi Arabia in the field of enhanced oil recovery. This method has not been investigated before in the Arabian area in general and in Saudi Arabia in specific. It is evident to note that some of the Saudi reservoirs are characterized by high salinity of interstitial water which reaches as high as 30%. However, in our case study, 4.2 and 10% salinities were chosen.

Experimental Work

Oil samples were obtained from bottom-hole on the same day of primary cultivation on bacteriological media. Samples were transferred in sterile plastic universal containers (60 ml capacity) and kept tightly closed until used within 1-2 hours.

Sterile cotton-tipped swabs were immersed in oil samples and excess oil was drained away by pressing against the vessel wall. These were then used to streak over the entire surface of human blood agar plates and Mueller-Hinton agar plates. For each oil sample two plates were incubated aerobically and anaerobically (in an anaerobic jar) overnight at 37°C. Plates were examined for growth of bacterial colonies in aerobic and anaerobic cultures. Anaerobic plates were reincubated for two days before discarding as negative cultures.

Isolated bacteria were propagated on MHA plates by the streaking technique and pure cultures were maintained on MHA slopes at room temperature. Sub-cultures were made every 2-3 weeks. Isolates were then subjected to the following tests:

- 1) Gram stain
- 2) Facultative growth
- 3) Colonial morphology
- 4) Type of hemolysis
- 5) Lactose fermentation
- 6) Catalase test
- 7) Oxidase test
- 8) Nitrate reduction test
- 9) Oxidation/fermentation test
- 10) Triple sugar-iron test
- 11) Urease test

The nutrients tested for growing of bacteria were molasses, glucose and sucrose. Molasses (cane molasses) was obtained from the market. If a molasses solution is sterilized by autoclaving, it is designated as molasses. The non-sterilized molasses solution is designated as commercial molasses. The surface phenomena measure-

ments conducted were surface tension, viscosity, pH-values and acidity. The surface tension and viscosity of bacterial solutions were measured by the digital tensiometer (K-10) and Brookfield viscometer, respectively. PH-values of the effluent aqueous and oleic phases were measured by using the digital pH-meter. The organic acidities of crude oils were determined using the Institute of Petroleum procedures [23]. The properties of Safaniya and Hawtah crude oils are given in Table 1.

Table 1. Properties of Safaniya and Hawtah crude oils

Property	Safaniya crude oil	Hawtah crude oil
API gravity	29.39	52.65
Viscosity, cp	34.45	1.811
Organic acidity number, mg KOH/g per sample of oil	1.4	1.2

Displacement Procedure

The setup used in the displacement experiments is given in Fig. 1. The porous media employed in the experiments consisted of unconsolidated sand (250 and 500 mesh size). The model used was manufactured from tofelon. The inner dimensions of the model were 48.38 cm length and 5.0 cm diameter. It was equipped with an injector and a producer on both ends. Screens were fixed around the bottom part of the injector and producer to prevent sand movement. Two stainless-steel tanks were used for oil and water. Two tofelon tanks were used for nutrient and bacterial solutions. Jeffri pump was used to provide a constant rate of injected water in the model (flow rate ranged from 0.044 to 0.056 ml/s).

The pressure at the inlet of the model was measured by a pressure gauge. The model was packed homogeneously with sand. The sand pack had a permeability of about 0.451 D for 250 μm sand pack and 3.736 D for 500 μm sand pack. The sand was first thoroughly washed by tap water, then by a dilute HCl solution and again by distilled water. After that it was dried. The model was then saturated with brine water having the TDS of 4.2% or 10%. From the volume of the water used for the saturation process, the effective porosity of the sand was calculated. In all sets of displacement experiments, the effective porosity of the sand pack was in the range of 0.35 for 250 μm sand pack and 0.37 for 500 μm sand pack. Absolute permeability was obtained by circulating formation water through the sand pack and measuring the flow rate of water at a given pressure drop across the sand pack. The model was then saturated with oil by the continuous injection of oil until the water cut in the effluent

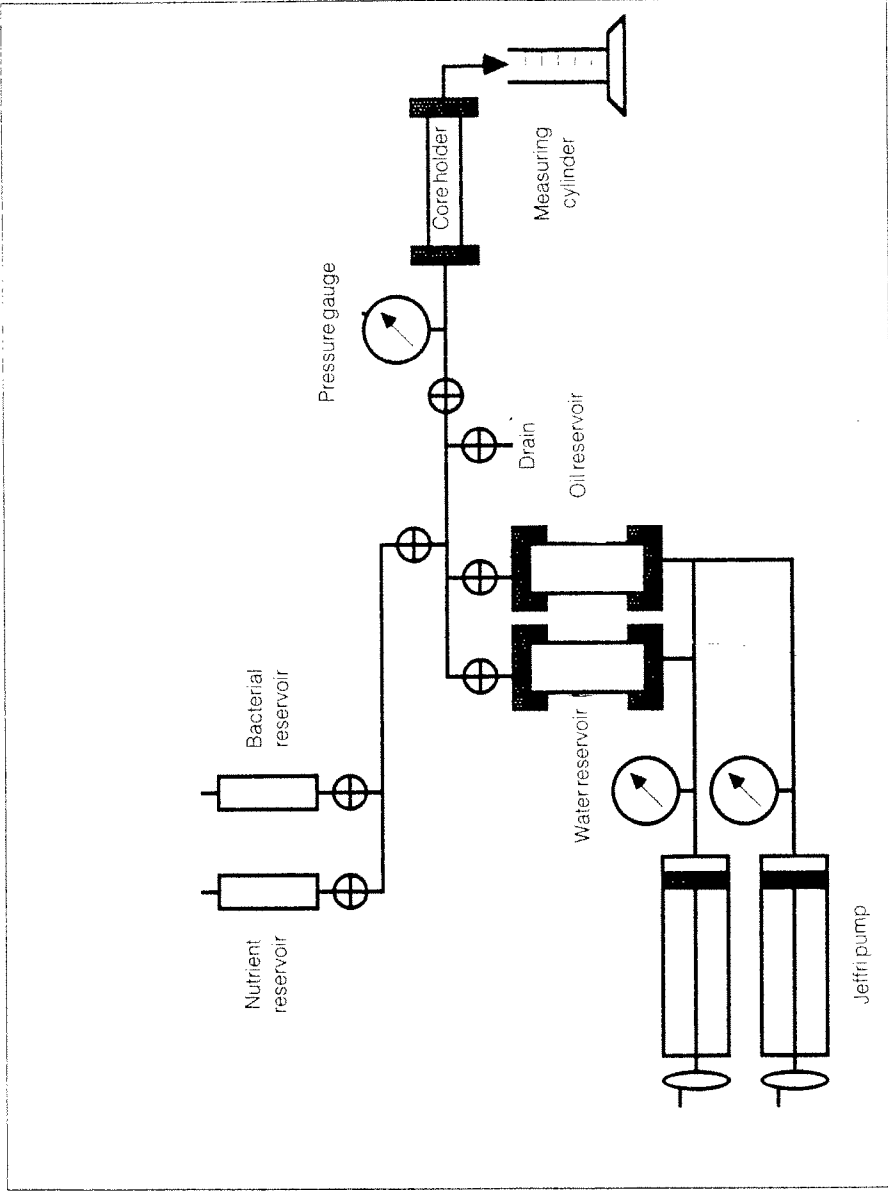

Fig. 1. Schematic diagram of displacement apparatus.

was less than 1%. At this moment, the initial saturation conditions of the model were assumed to be achieved, and the seawater was injected into the sand pack, for about two pore volumes. The liquid produced were collected continuously, and the amount of oil and water in the sample were determined. After that nutrient with bacteria was injected into the sand pack for about 0.4 pore volume, then incubated for 48 hours, followed by continuous injection of seawater for about one pore volume. The liquids produced were collected continuously, and the amount of oil and water in the sample were determined.

Results and Discussion

The characteristics of the twelve bacterial strains that were isolated from Saudi crude oils and formation water are given in Table 2. The values of surface tension and viscosity of the bacterial cultures are given in Table 3. Tables 2 and 3 show that the bacterial strain-O_{6a} and strain-O₁₂ in glucose media produce surface active compounds such as alkaline and surfactant by which the values of the surface tension were reduced to minimum values. In addition, the highest value of the viscosity was obtained from the bacterial culture of strain-O₉. This means that the bacterial strain-O₉ produces polymers. Thus, the bacterial strain-O₁₂, strain-O₉ and strain-O_{6a} were selected for displacing tests. Fourteen displacement runs were conducted, and the data of these runs are given in Table 4. This table shows that activating the indigenous bacteria in Safaniya oil with molasses using the bacterial strain-O₉ in sucrose to recover Hawtah oil result in the greatest oil recovery.

Effect of nutrient type

The effect of nutrient types (sucrose, glucose and molasses) on the efficiency of the indigenous microbial displacement was studied. Figures 2 and 3 show the variation of percentage of oil in sample produced, cumulative oil recovery, and percentage of original oil in place with nutrient type at 23°C. Under the experimental conditions used, the most attractive performance is the use of commercial molasses as nutrient. It gives the highest oil recovery (as seen in Fig. 3) and a large oil-water bank as shown in Fig. 2. This result does correlate directly with the behavior of pH and pressure as shown in Figs. 4 and 5, respectively. Figure 4 shows the pH-values of effluents using different types of nutrient. It is clear that, bacteria consume commercial molasses (1% concentration) and produce alkali. Figure 5 shows the pressure measurements during incubation period at which the pressure builds up due to gases production. The pressure increases with increasing time. It also shows that the highest pressures are obtained when bacteria consume glucose. It is evident to note that the production of gases may account for incremental oil recovery by bacteria.

Table 2. Different types of bacteria and Saudi reservoir characteristics

No	Field	Reservoir	Strain No	G.S	Morph	S.F	Colonial Pigment	Type of Hemolysis on B.A	Growth in		MacCo-nckey's agar	Cat	Ond	NO ₃ Red	O/F			Ure	TSI		H ₂ S	
									+C ₂	-O ₂					O	F	Type		S	B		
1	Safaniya	Safaniya	W1	+	Bacilli	---	---	weak α	+	+	Lac ⁻	+	-	+	Alk	-	NF	-	Alk	-	-	
			C1,2	+	Bacilli	+	-	-	α	+	+	Lac ⁻	+	ND	ND	±	ND	-	Alk	Ac	-	-
2	Qhawar	Shedgum	W4	-	Bacilli	-	-	α	+	+	Lac ⁻	+	+	+	+	+	NF	-	-	-	-	-
			O2b	+	Cocci	-	-	-	β	+	+	Lac ⁺	+	+	+	+	+	F	-	Ac	Ac	-
			O5b	+	Cocci	-	-	-	β	+	+	Lac ⁺	+	+	+	+	+	F	-	Ac	Ac	-
			O3	+	Cocci	-	-	-	-	+	ND	ND	+	ND	ND	ND	ND	F	-	ND	ND	-
3	Hawrah	Fazran	O10	+	Cocci	-	buff-cream	β	+	+	Lac ⁻	+	ND	ND	+	+	F	-	Ac	-	-	
			O10a	+	Cocci	-	Citrus-yellow	γ	+	+	Lac ⁻	+	ND	ND	Alk	-	NF	-	Alk	-	-	
			O9	+	Cocci	-	-	β	+	+	Lac ⁻	+	ND	ND	+	+	F	-	Ac	-	-	
4	Marjan	Khafji	O6	+	Cocci	-	Citrus-yellow	γ	+	+	Lac ⁻	+	ND	ND	Alk	NF	-	-	-	-	-	
			O6a	+	Cocci	-	-	-	β-double zone	+	+	Lac ⁻	+	ND	ND	Alk	NF	-	Alk	-	-	
5	Abu Safah	Arab-D	O15	+	Cocci	-	Yellow-ish	β	+	+	Lac ⁺	+	ND	ND	+	+	F	-	Ac	Ac	-	

W - strain isolated from water
 O - strain isolated from oil
 G.S - Gram stain
 Morph - morphology
 S.F - spore formation
 B.A - blood agar
 +O₂ - in presence of oxygen
 -O₂ - in absence of oxygen
 ND - not done
 cat - catalase
 Ond - oxidase
 NO₃ red - NO₃ reduction
 Ure - urease
 + - positive reaction
 - - negative reaction
 α - incomplete hemolysis of human blood
 β - complete hemolysis of human blood
 γ - no hemolysis of human blood
 Lac⁺ - ferments lactose
 Lac⁻ - non-lactose fermenter
 O/F - O/F
 O - oxidation
 F - fermentation
 NF - non-fermentation
 TSI - triple-sugar iron test
 S - slant reaction
 B - Butt reaction
 H₂S - hydrogen sulfide production
 Alk - alkaline reaction
 Ac - acidic production

Table 3. Surface tension and viscosity for different type of bacteria

Type of bacteria	Surface tension (dyne/cm ²)		Viscosity (at shear rate 73.4 sec ⁻¹) (cp)	
	Glucose media	Sucrose media	Glucose media	Sucrose media
Pure media	55.91	55.91	1.19	1.14
W ₁	61.60	60.55	1.12	1.10
W ₄	61.15	61.45	1.21	1.18
O _{2b}	60.80	61.30	1.12	1.12
O ₃	55.05	60.20	1.11	1.145
O _{5b}	61.30	60.80	1.09	1.10
O ₆	61.45	62.40	1.09	1.09
O _{6a}	34.35	62.15	1.31	1.08
O ₉	56.14	55.15	1.245	1.98
O ₁₀	61.10	60.60	1.15	1.11
O _{10a}	62.35	58.75	1.105	1.10
O ₁₂	31.80	31.60	1.35	1.4
O ₁₅	60.20	59.20	1.12	1.10

Effect of bacterial type

The effect of bacterial types (O_{6a}, O₉ and O₁₂) on the displacement efficiency was studied. Figures 6 and 7 show the percentage of oil produced in sample and cumulative oil recovery percentage of original oil in place with pore volumes produced for different types of bacteria. It is seen from these experiments that most of the bacterial types tested in this study recover more oil in the testing process as indicated from Fig. 7. However, the ability of the microorganism O₁₂ in glucose to lower interfacial tension was not a reflection on the ability of these surfactant to extract or mobilize crude oil. This may be due to the incompatibility between the microorganism and the indigenous organisms.

Very little is known about the exact mechanism of oil release in microbial enhanced oil recovery. However, growth of microbes *in situ* may have a number of potentially important interactions with the inorganic matrix and the oil present in a porous media. Growth in organic or inorganic substrata can create metabolic products such as acids, gases, surfactant and biopolymers. This shows that the bacterial inoculum represents the major component injected into the formation. Therefore, the increase in ultimate oil recovery is evidenced by production of a large oil-water bank or by delayed oil production as seen in Fig. 6. Urea can be used as a sole nitro-

Table (4) Data of Displacement Runs

Exp. No.	ϕ %	k darcy	Formation salinity %	Residual oil after water flooding, RO %	Bacterial type	Nutrient type**	Crude Oil	Pressure at the end incubation time, psig	pH of prod. water	Oil Rec., % of RO
1	35.92	0.452	4.212	39.54	I.B.*	Glucose	Safaniya	4.25	6.18	46.15
2	36.06	0.454	4.212	56.09	I.B.	Sucrose	Safaniya	4.80	6.13	31.35
3	34.96	0.441	4.212	54.53	I.B.	2% molasses	Safaniya	1.20	5.87	46.71
4	35.14	0.448	4.212	47.07	I.B.	1% molasses commercial	Safaniya	4.35	6.68	81.71
5	34.98	0.455	4.212	42.45	I.B.	1% molasses	Safaniya	4.50	6.73	79.56
6	35.17	0.449	4.212	43.46	O _{6a}	Glucose	Safaniya	4.00	6.50	47.35
7	35.71	0.453	4.212	39.62	O ₁₂	Glucose	Safaniya	3.30	6.73	27.86
8	35.12	0.448	4.212	39.69	O ₉	Glucose	Safaniya	9.05	6.99	44.95
9	35.27	0.453	4.212	42.15	O ₉	Sucrose	Safaniya	12.8	6.69	46.82
10	35.73	0.445	4.212	49.45	O ₉	Glucose & Urea	Safaniya	6.40	7.92	35.13
11	35.59	3.736	4.212	43.26	O ₉	Sucrose	Safaniya	10.5	6.20	45.49
12	35.42	0.455	10.00	48.47	O ₉	Sucrose	Safaniya	8.45	6.38	44.21
13	35.49	0.461	4.212	18.13	O ₉	Sucrose	Hawtah	12.9	6.32	10.99
14	35.81	0.453	4.212	100.0***	O ₉	Sucrose	Hawtah	10.5	7.02	82.85

* I.B. = indigenous bacteria

** Slug size 0.4 P.V. concentration 1%

*** Injected in secondary stage

ϕ = porosity, %

k

= permeability, darcy

Rec

= recovery

RO

= residual oil

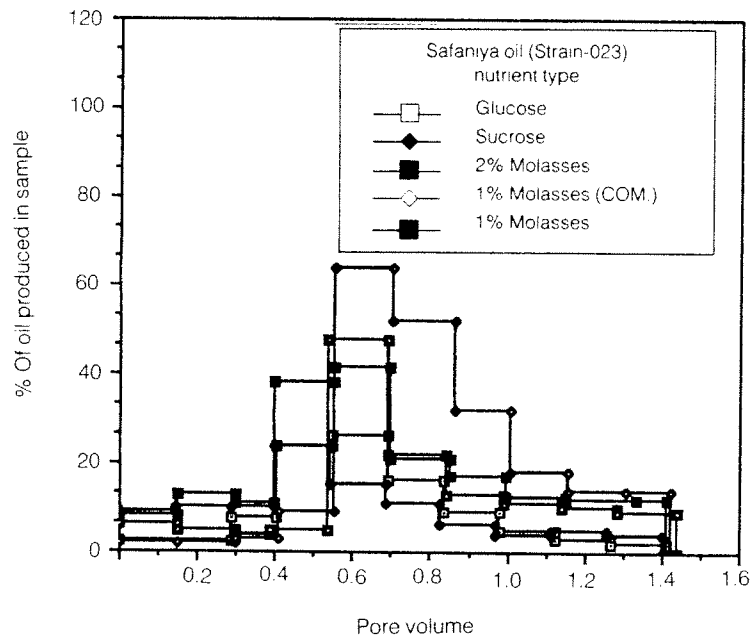

Fig. 2. Effect of nutrient type on % of oil produced in sample.

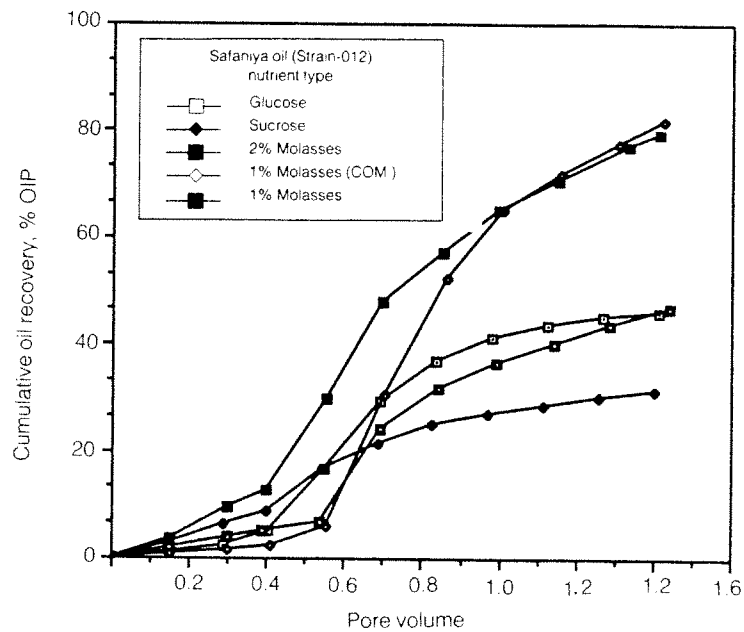

Fig. 3. Effect of nutrient type on cumulative oil recovery.

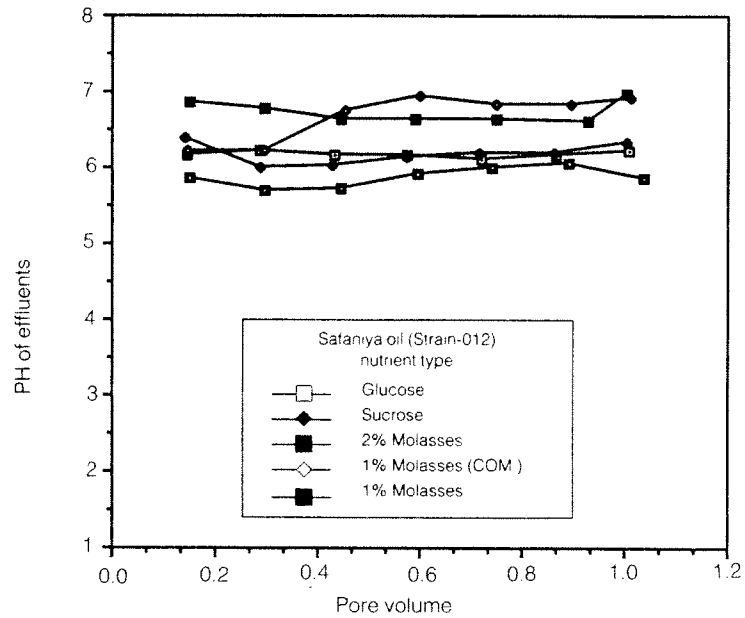

Fig. 4. Effect of nutrient type on pH values of the effluents.

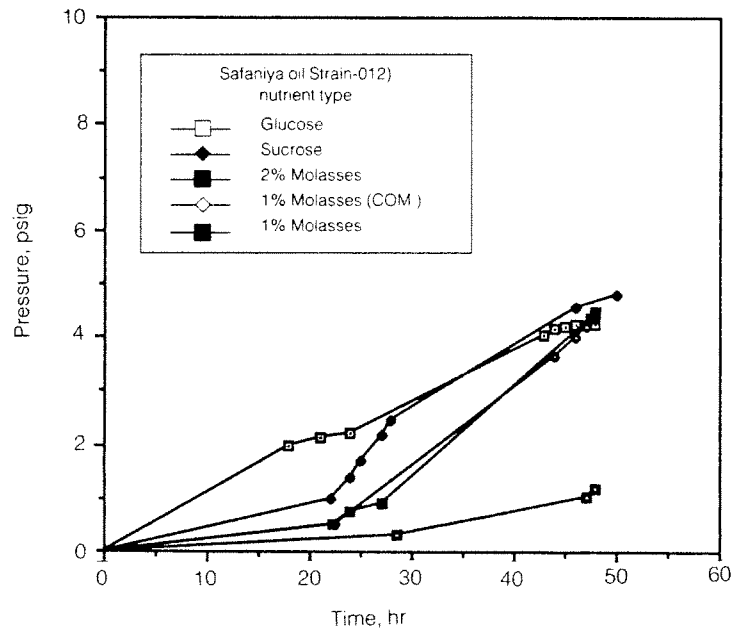

Fig. 5. Effect of nutrient type on model pressure during incubation period.

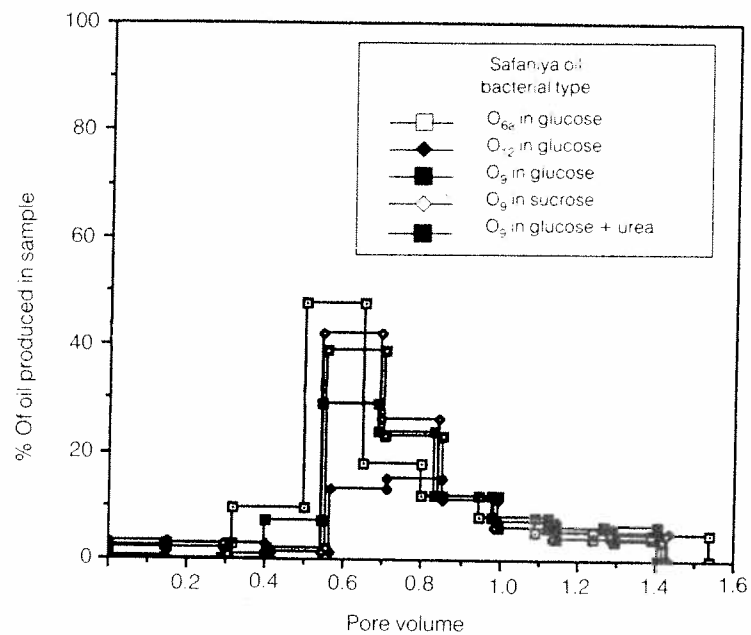

Fig. 6. Effect of bacterial type on % of oil produced in sample.

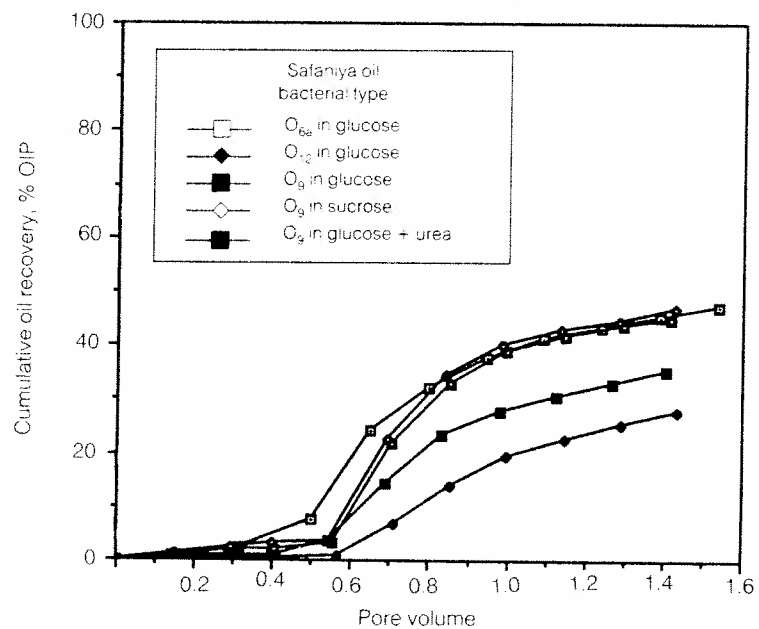

Fig. 7. Effect of bacterial type on cumulative oil recovery.

gen source both for growth and for surfactant production. This is indicated by the high pH as shown in Fig. 8.

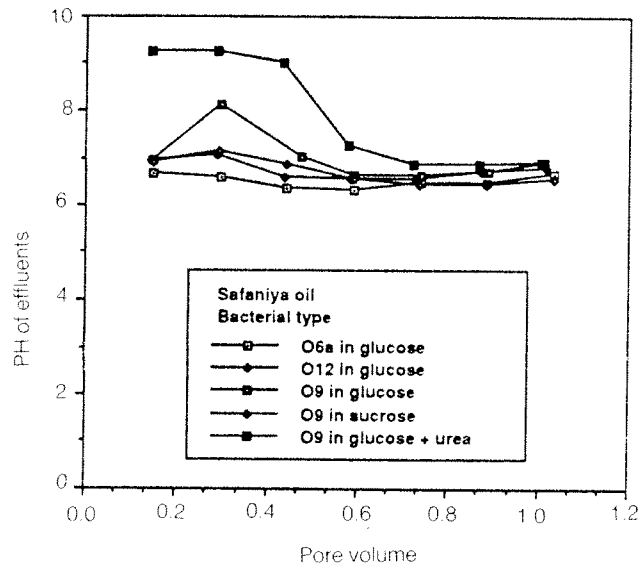

Fig. 8. Effect of bacterial types on pH of effluents.

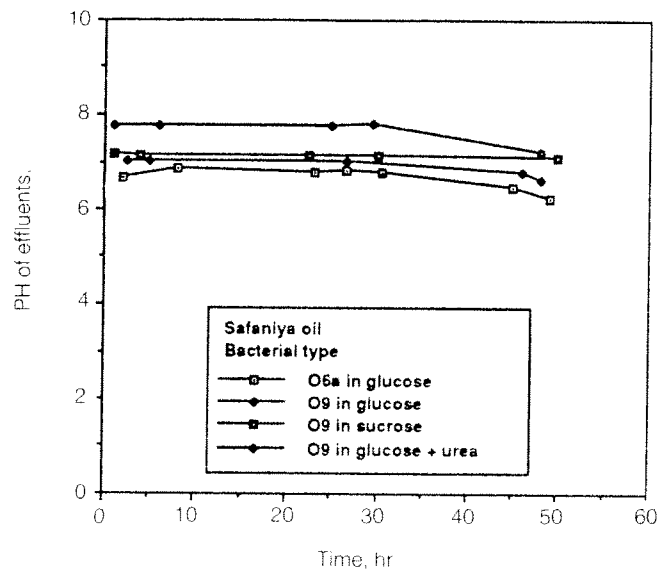

Fig. 9. Variation of pH of effluents with time for O_{6a} and O_9 .

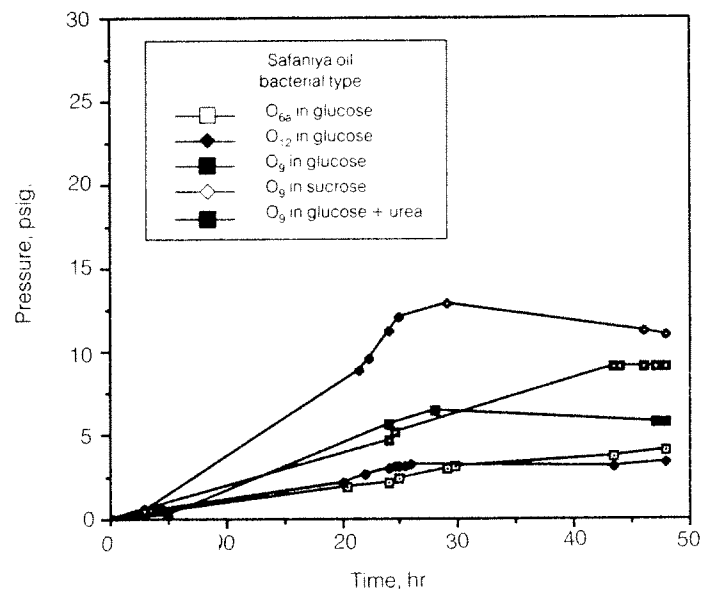

Fig. 10. Variation of model pressure during incubation period with time after injecting different bacterial types.

Figures 8 and 9 show the variation of pH during the displacement process when using different types of microorganisms. It is clear that the microorganism O_9 and urea in glucose solution produce more alkali. This is indicated by the high value of pH as seen in these figures. On the other hand, Fig. 10 illustrates the variation of pressure with time or different types of bacteria tested in this work. It can be seen that the presence of organisms O_9 in sucrose and glucose solutions resulted in high pressure. This indicates that this type of organisms produce more gases.

The effect of surfactant metabolites of different bacteria on the interfacial tension between crude oil and bacterial solution is demonstrated by interfacial tension measurements. Figure 11 shows the interfacial tension versus time for different types of organisms. It is clear that microorganism O_{12} in sucrose solution gives the lowest interfacial tension which may indicate the production of biosurfactant by this organism.

Effect of permeability variation

Two experimental runs were devoted to investigate the effect of changing permeability from 453 to 3738 md. Figure 12 illustrates the production history for microbial enhanced recovery from 453 to 3738 md sandpacks. It is clear that the ultimate oil recovery is the same in both cases. However, the percentage of oil produced in

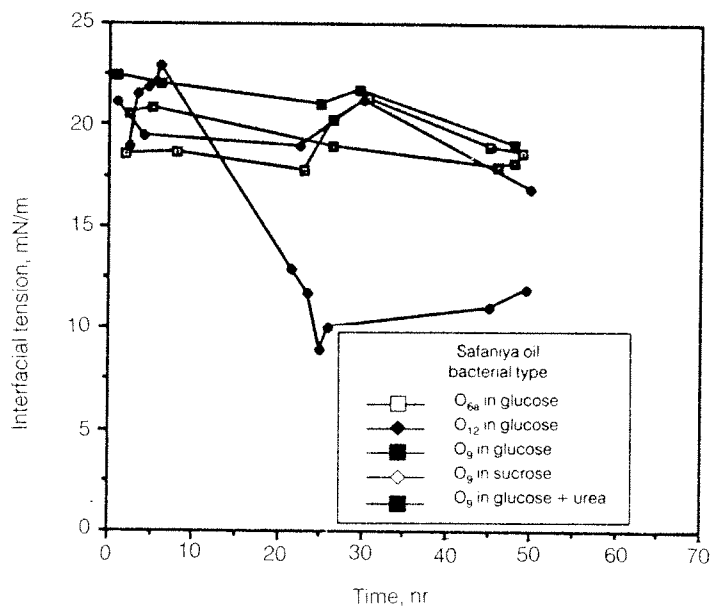

Fig. 11. Variation of interfacial tension with time for different bacterial types.

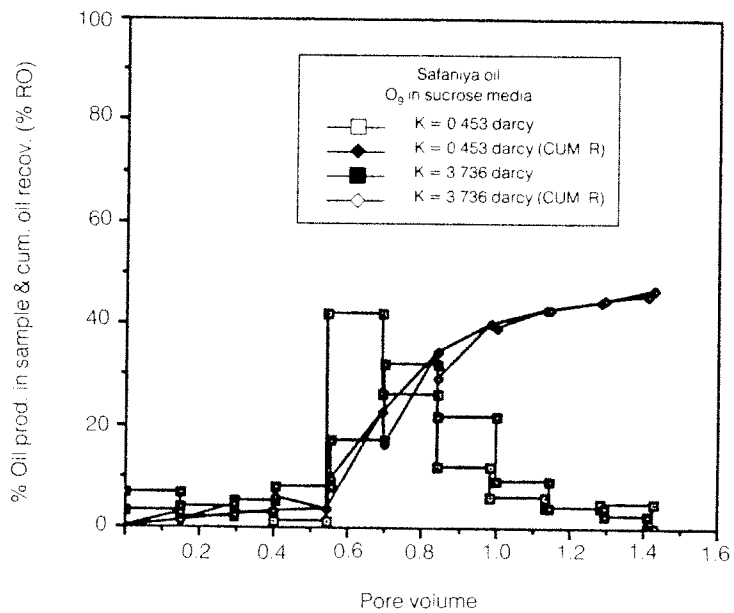

Fig. 12. Effect of permeability on production history for O_9 in sucrose solution.

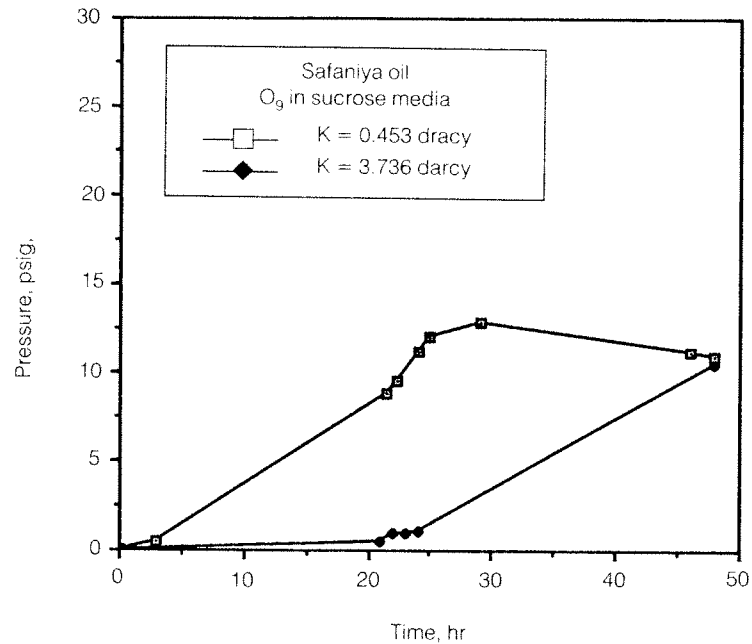

Fig. 13. Variation of model pressure with time after injecting O_9 in sucrose for different permeabilities.

sample in the case of high permeability is more than that of low permeability. Also, the pressure was higher in the case of lower permeability as shown in Fig. 13.

Effect of formation water salinity

Two displacement runs were carried out to investigate the effect of increasing synthetic brine water salinity from 4.2% to 10% by weight TDS. The production history results of these experiments are presented in Fig. 14. The cumulative oil recovery in both cases is almost the same. However, at low salinity the breakthrough of water bank was delayed. The behavior of pH versus cumulative pore volumes produced is shown in Fig. 15. This figure indicates that the pH value of 4.2% salinity is higher. This may indicate that the microorganism produce more alkali at lower salinity.

On the other hand, the organism O_9 in sucrose media produced some gases at lower salinity value as indicated by the higher pressure shown in Fig. 16.

Effect of API gravity

Two displacement runs were carried out to investigate the effect of crude oil type on displacement efficiency. Figure 17 shows the production history and cumulative recovery when using Safaniya and Hawtah crude oils.

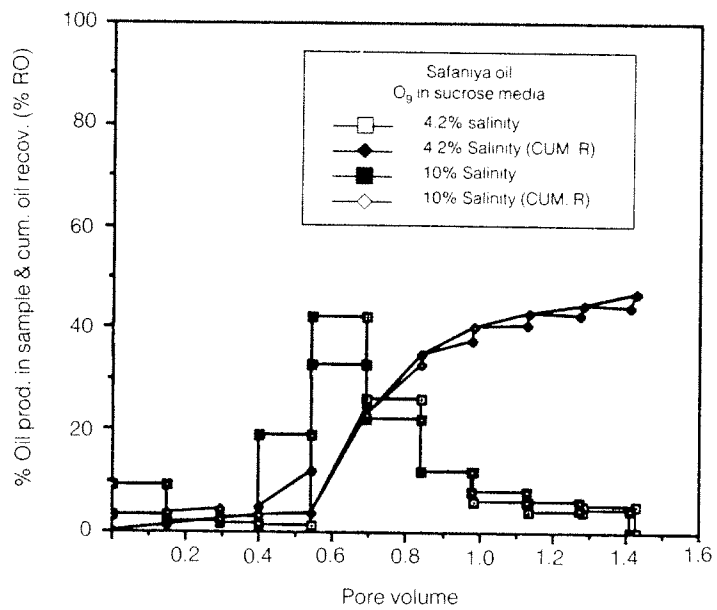

Fig. 14. Effect of salinity on production history for O_2 in sucrose solution.

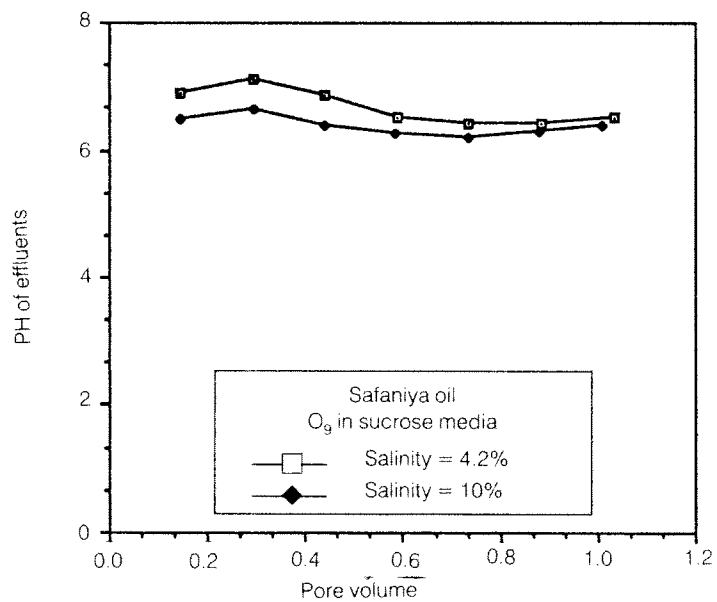

Fig. 15. PH of effluents as a function of pore volumes produced for O_2 in sucrose for different salinities.

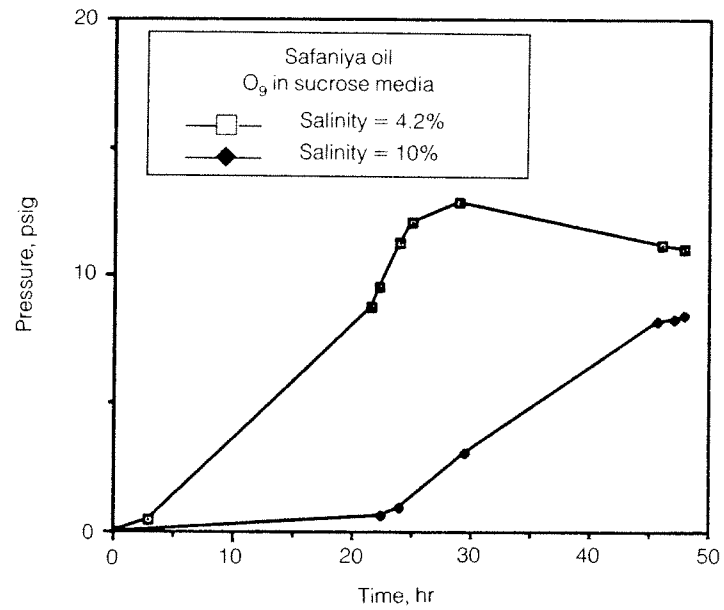

Fig. 16. Variation of model pressure with time after injecting O_2 in sucrose for different salinities.

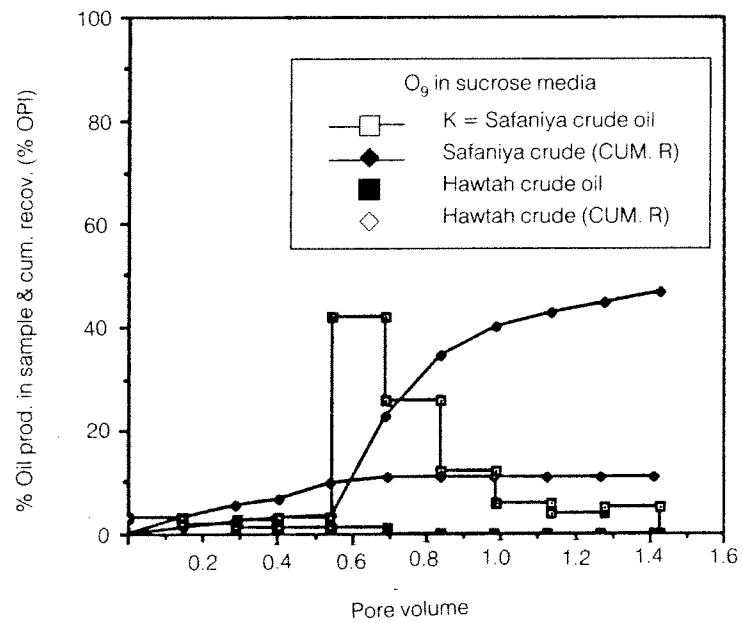

Fig. 17. Production history for Safaniya and Hawtah crude displacement by O_2 .

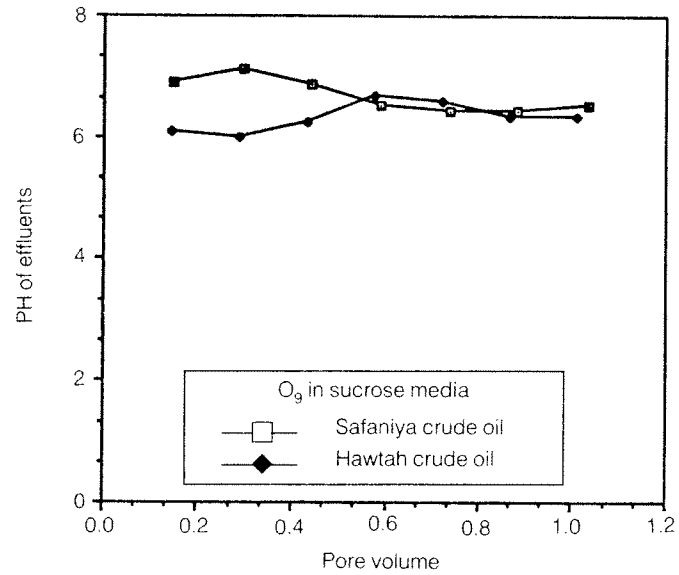

Fig. 18. PH of effluents versus pore volumes produced for displacement of Safaniya and Hawtah crude by O_2 .

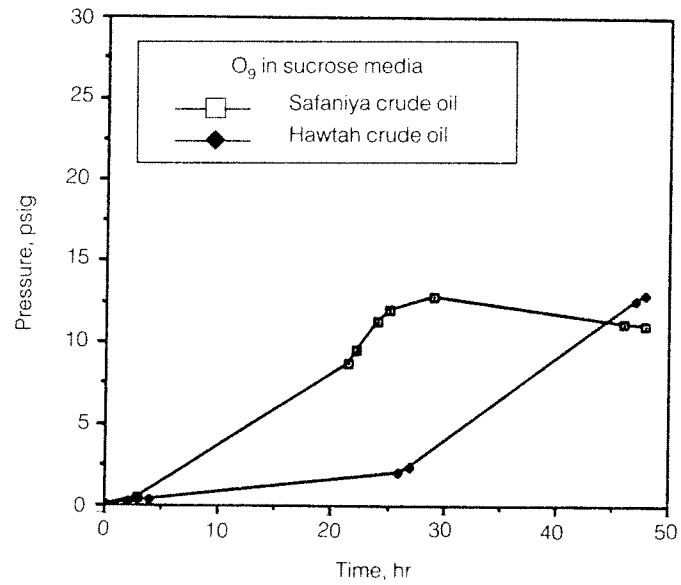

Fig. 19. Variation of model pressure with time after injecting O_2 in sucrose for different crude oils.

It is clear that the displacement process is more successful in the case of using Safaniya crude oil (API = 29.39°) than Hawtah crude (API = 52.65°). This is due to the effect that the value of the residual oil in using Safaniya crude is approximately three times that of Hawtah crude. Figures 18 and 19 show the behavior of pH and pressure with time during the displacement process, respectively. After 40 hours, it is seen that the pressure almost the same as shown in Fig. 19.

Conclusion

1. Bacteria strains O₁₂ and O_{6a} produced gases and surfactants, while the bacterial strain O₉ when cultured in sucrose media produced polymers.
2. Using molasses to activate the indigenous bacteria resulted in a higher recovery of oil.
3. The bacterial strains O_{6a} and O₉ showed the best results in increasing oil recovery.
4. The changes in sandpack permeability or API gravity have no effect on oil recovery.
5. A very little variation in oil recovery was obtained by increasing salinity from 4.2 to 10%.

References

- [1] Bubela, B. "Combined Effects of Temperature and Other Environmental Stresses on MEOR." In: Donaldson, E.C. and Clark, J.B. (Eds.): *Proceed., 1982 Intl. Conf. on Microbial Enhancement of Oil Recovery*, Afton, OK, May 16-21, 1983. Springfield, VA: NTIS, 118-123.
- [2] Moses, V. and Springham, D.G. "Bacteria and the Enhancement of Oil Recovery." London: Applied Science Publishers, 1982.
- [3] Grula, E.A. *et al.* "Isolation and Screening of Clostridium for Possible Use in MEOR." In: Donaldson, E.C. and Clark, J.B. (Eds.), *Proceed. 1982 Intl. Conf. on Microbial Enhancement of Oil Recovery*, Afton, OK, May 16-21, 1983. Springfield, Va.: NTIS, 43-47.
- [4] Backman, J.W. "The Action of Bacteria on Mineral Oil." *Int. Eng. Chem.*, 4 (10 Nov., 1926), 23-26.
- [5] ZoBell, C.E. *Bacteriological Process for Treatment of Fluid-bearing Earth Formations*, U.S. Patent No. 2413278, Dec. 24, 1947.
- [6] ZoBell, C.E. *Recovery of Hydrocarbons*. U.S. Patent No. 2641566, 1953.
- [7] Kuznetsov, S.T.; Ivanov, M.V. and Lyalikova, N.N.L. "Introduction to Geological Microbiology." McGraw-Hill, New York, 1963.
- [8] Senyukov, V.M., *et al.* "Mikrobiologicheski Metod Obrabotki Neftianoj Zalozy Svisokoi Mineralizatsey Plastovykh Vod." *Mikrobiologiya*, 39, No. 4 (1970), 705-710.
- [9] Grula, E.A.; Russell, H.H. and Grula, M.M. "Field Trials in Central Oklahoma/Using Clostridium Strains for Microbially Enhanced Oil Recovery." In: Zajic, J.E and Donaldson, E.C. (Eds.) *Microbes and Oil Recovery*. El Paso, Texas: Bioresources Publications, 1985, 144-150.

- [10] Donaldson, E.C. and Grula, E.A. "There are Bugs in my Oil Well." *CHEMTECH*, 5, (October 1985), Vol. 3, 602-604.
- [11] Torbati, H.M. *et al.* "Effect of Microbial Growth on Pore Entrance Size Distribution in Sandstone Cores." *J. Ind. Microbiology*, 1, (1986), 227-234.
- [12] Bryant, R.S. and Douglas, J. "Evaluation of Microbial Systems in Porous Media for EOR." *SPE Reservoir Engineering, Trans. AIME*, 4, No. 2 (May, 1988), 489-495.
- [13] Bryant, R.S. and Thomas, E.B. "Review of Microbial Technology for Improving Oil Recovery." *SPE Reservoir Engineering*, Vol. 5, No. 2 (May, 1989), 151-154.
- [14] Bryant, R. "MEOR Screening Criteria Fit 27% of US Oil Reservoirs." *Oil and Gas Journal*, April 15, Vol. 89, No. 14 (1991), 56-59.
- [15] Donaldson, E.C. (Ed.) "Microbial Enhancement of Oil Recovery Recent Advances." *Proceedings of the Intl. Conf. on MEOR*, Norman, OK, U.S.A. (27 May - 1 June, 1990).
- [16] Hitzman, O.D. "Review of Microbial Enhanced Oil Recovery Field Trials." *Proceedings of the Symp. on Application of Microorganisms to Petrol. Technol.*, Bartesville, OK., Sept. 1988.
- [17] Bryant, R.S. and Douglas, J. "Evaluation of Microbial Systems in Porous Media for Enhanced Oil Recovery." *Symp. on Oil Chemistry, San Antonio, Texas*: Feb. 1987, SPE Paper 16284.
- [18] Kyte, J.R. *et al.* "Mechanism of Water Flooding in the Presence of Free Gas." *Transactions, AIME*, 201, 1954.
- [19] Jack, T.R. and Thompson, B.G. *Patents Employing Microorganisms in Oil Production*. OK: Penn Well Books, 1983.
- [20] Hitzman, O.D. "Review of Microbial Enhanced Oil Recovery Field Trials." *Proceedings of the Symp. on Application of Microorganisms to Petrol. Technol.*, Bartesville, OK. Aug. 12-13, 1987, VII-VI42.
- [21] Dune, C.W.; Moreura, A. and Linden, J. "The Acetone-Butanol Fermentation of *Clostridium Acetobutylicu*." OK: Zajic Book, PennWell Books, 1983, 141-149.
- [22] Jang, L. *et al.* "An Investigation of the Transport of Bacteria Through Porous Media." *Intl. Conf. on MEOR*, OK, 1982. 60-70.
- [23] Institute of Petroleum. *IP Standards for Petroleum and Its Products, Part-1: Methods for Analysis and Testing*. London: The Institute of Petroleum, 1980.

دراسة معملية عن الاستخلاص المحسن للزيت بوساطة الميكروبات

محمد سعود البليهد، محمد حلمي صبيوح، حسين شعيب، علي محمد عواد،

سعد الدين محمد دسوقي و عادل محمد حميدة

قسم هندسة النفط، كلية الهندسة، جامعة الملك سعود، ص. ب. ٨٠٠،

الرياض ١١٤٢١، المملكة العربية السعودية

(سُلم في ١١/٥/١٩٩٤م؛ قُبل للنشر في ٢١/٦/١٩٩٥م)

ملخص البحث. تم فصل اثنتي عشرة سلالة بكتيرية من الزيوت السعودية والمياه المصاحبة للزيت. وأجريت التجارب المعملية لتوصيف السلالات المعزولة، وتحديد مكونات المغذيات، وقياس الشد السطحي والبينسطحي. وبناءً على النتائج التي تم الحصول عليها، اختيرت ثلاث سلالات من البكتيريا وهي: O_{12} ، O_{10} و O_9 لاستخدامها في تجارب الإزاحة. تم دراسة تأثير كل من نوع البكتيريا، نوع المغذي، النفاذية، درجة الكثافة النوعية (API gravity) والملوحة على كمية الزيت المستخرج.

وأظهرت النتائج أن السلالتين O_{12} و O_{10} أنتجتا غازات وسيرفاكتانت، بينما أنتجت السلالة الأخرى (O_9) البوليمرات، وأن أعلى عائد من الزيت استخرج عن طريق تنشيط البكتيريا الموجودة بالزيت باستخدام محلول قصب الدبس بتركيز ١٪ بالوزن، وأن حقن السلالتين O_{10} و O_9 مع مغذيات الجلوكوز يزيد من كمية الزيت المستخرج، وأن تغير النفاذية من ٤٥٣ إلى ٣٧٣٦ مللي دارسي أو تغير الملوحة من ٢، ٤ إلى ١٠٪ لا يؤثر على كمية الزيت المستخرج.